



赫兹电力  
HERTZ POWER

产品宗旨：技术领先，质量可靠，轻便易用

服务宗旨：快速响应，时间到满意，超过期





赫兹电力  
HERTZ POWER

产品宗旨：技术领先，质量可靠，轻便易用

服务宗旨：快速响应，**客户**到满意，**超过期**

赫兹电力  
HERTZ POWER

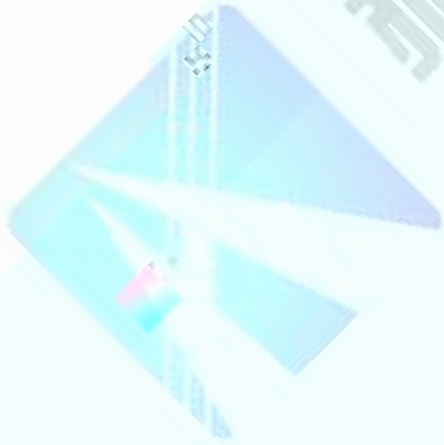



赫兹电力  
HERTZ POWER

产品宗旨：技术领先，质量可靠，轻便易用

服务宗旨：快速响应，**客户**到满意，**超过期**





--	--

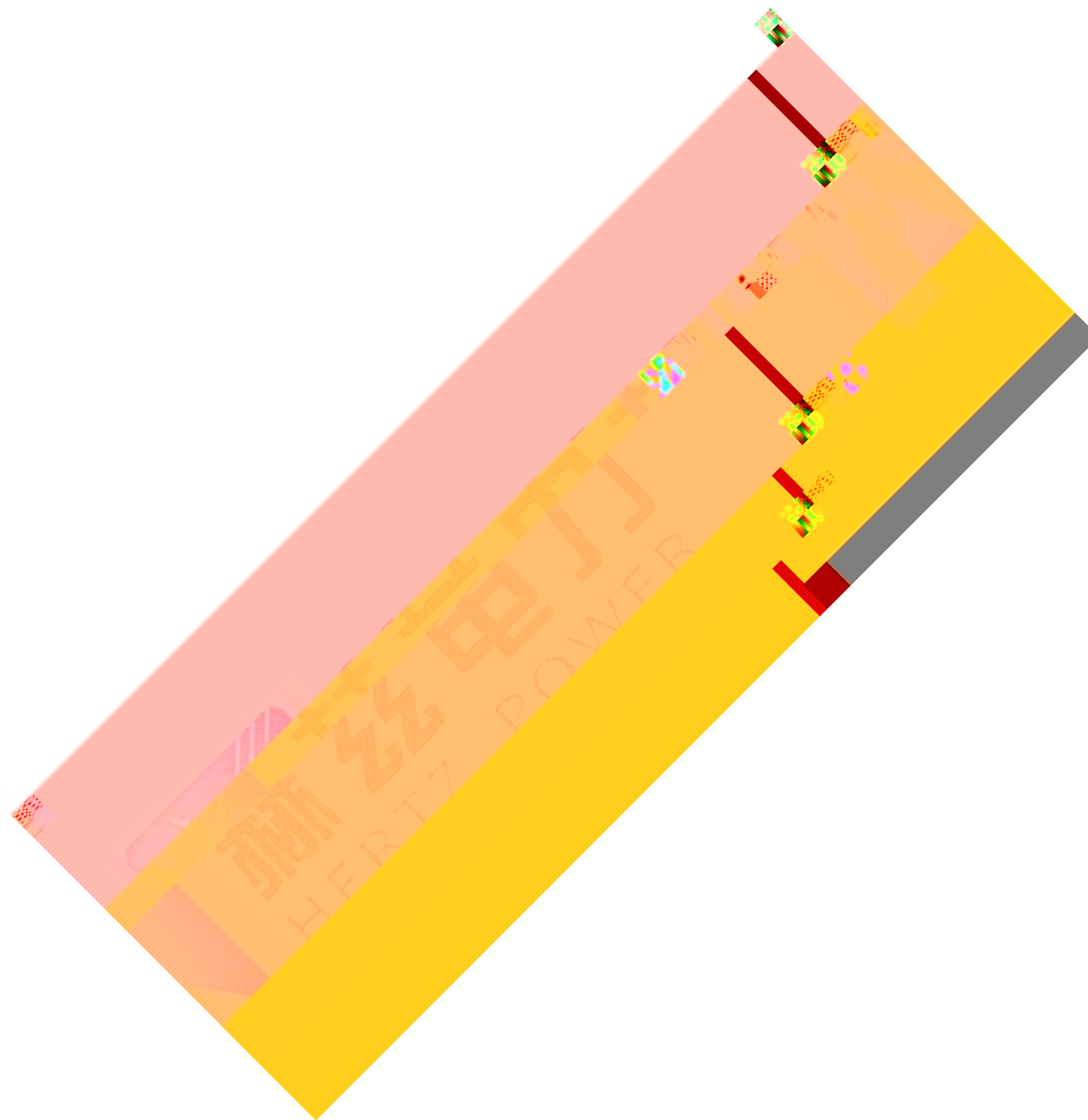

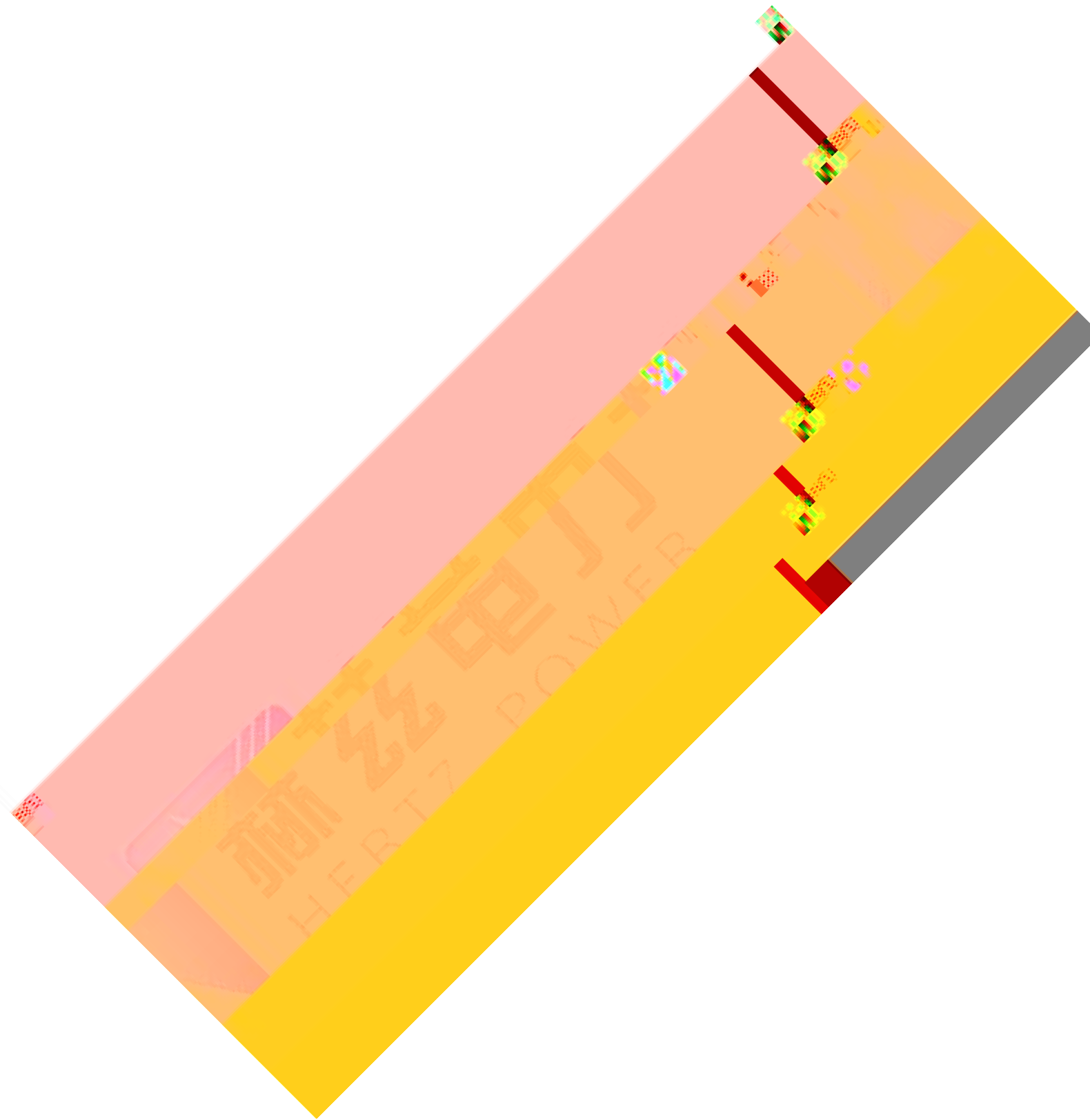



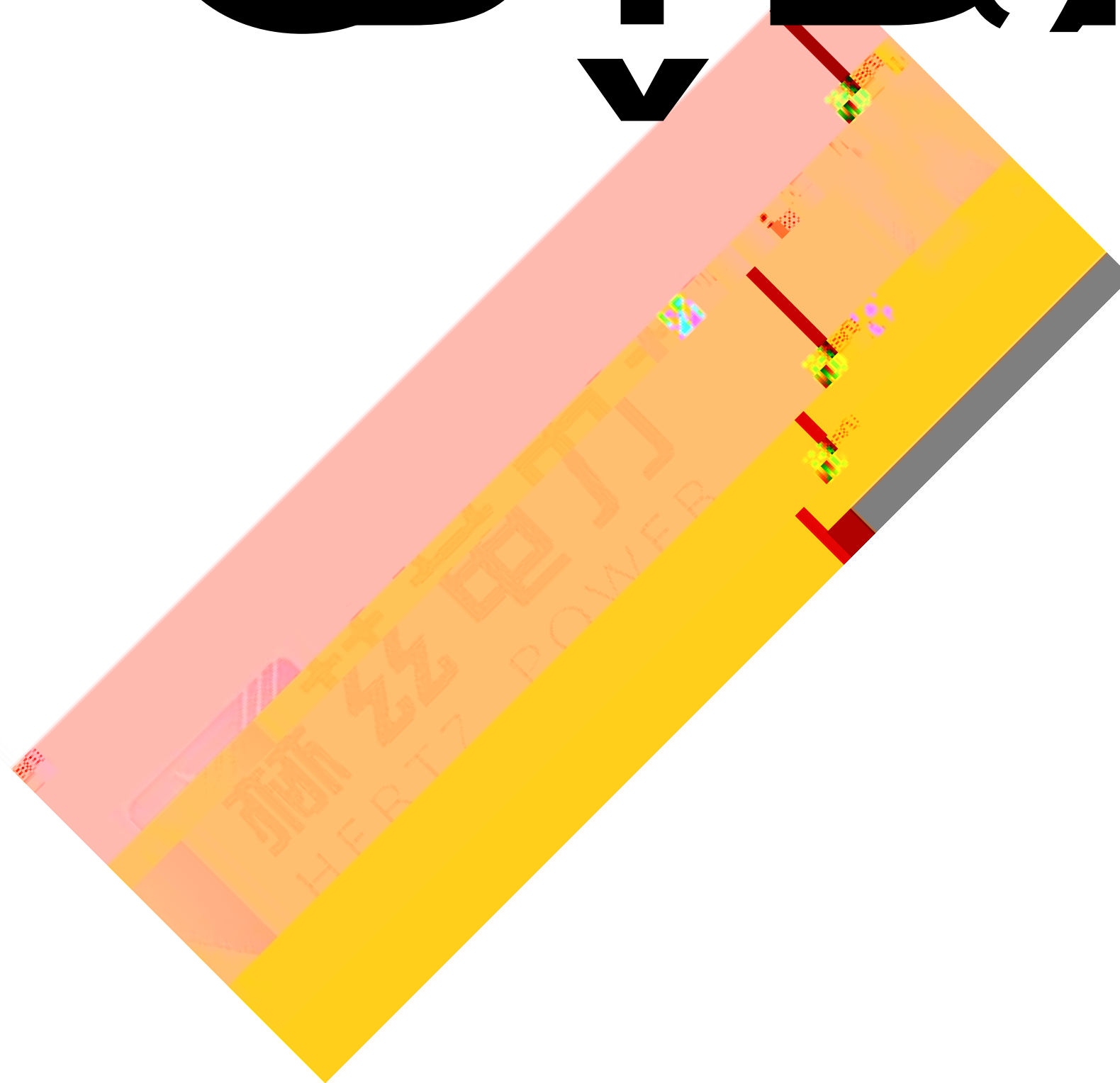

产品宗旨: 技术领先, 质量可靠, 轻便易用  
服务宗旨: 快速反应, 客户满意, 超过期望

# HERTZ POWER



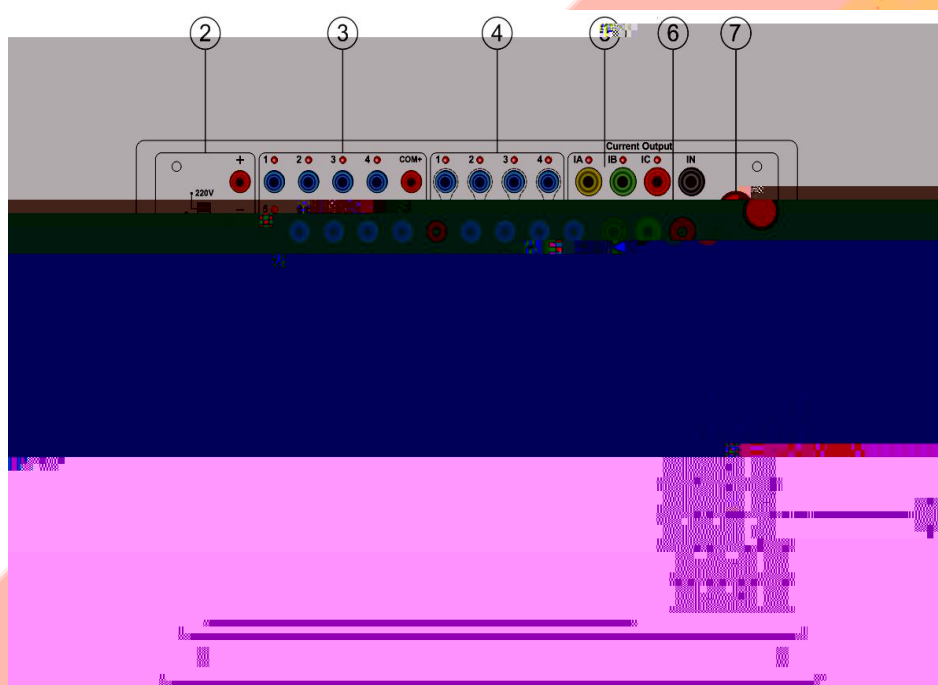

**V** **U**

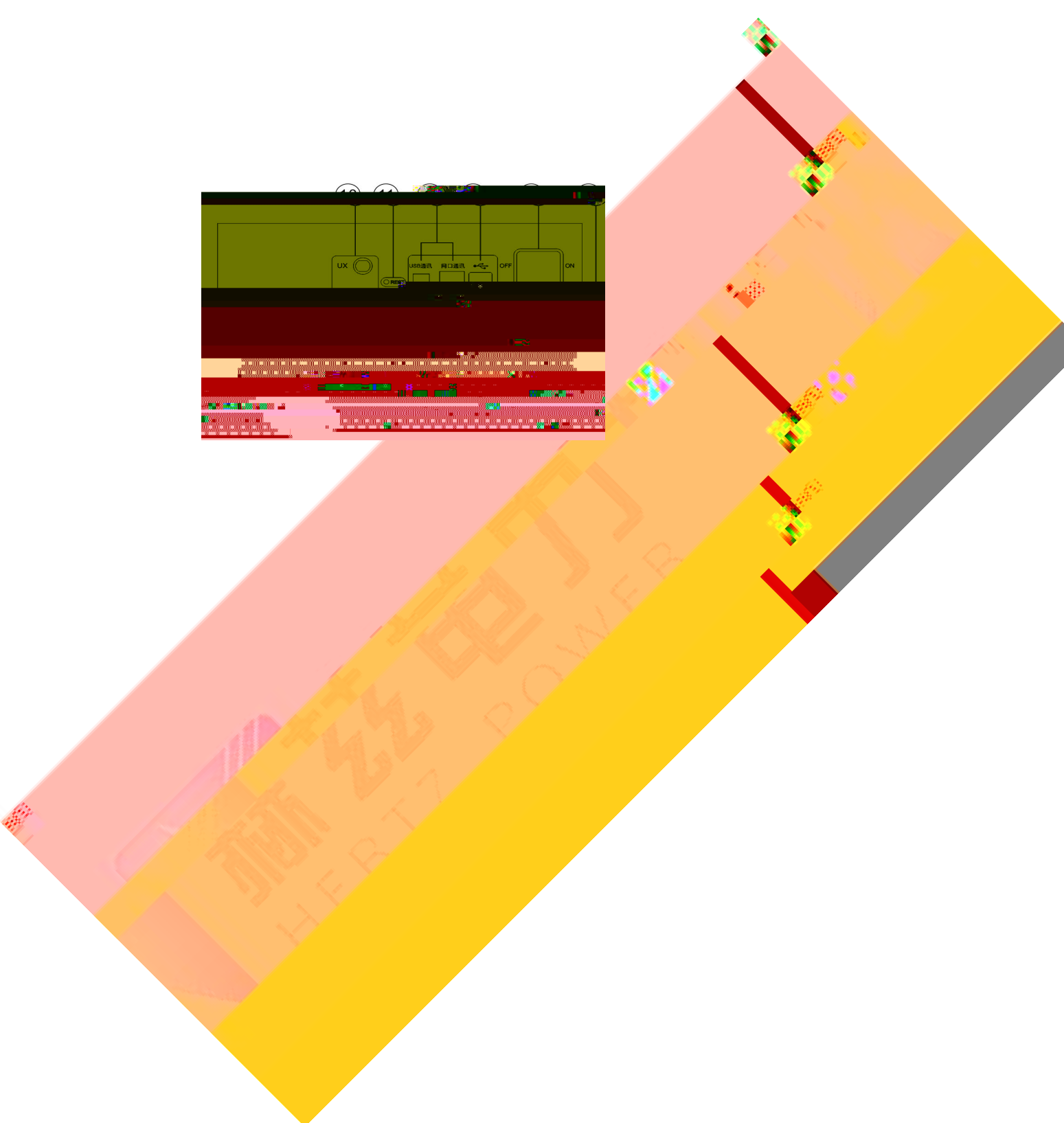
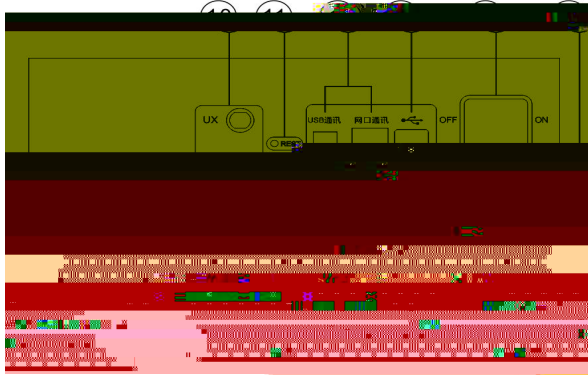

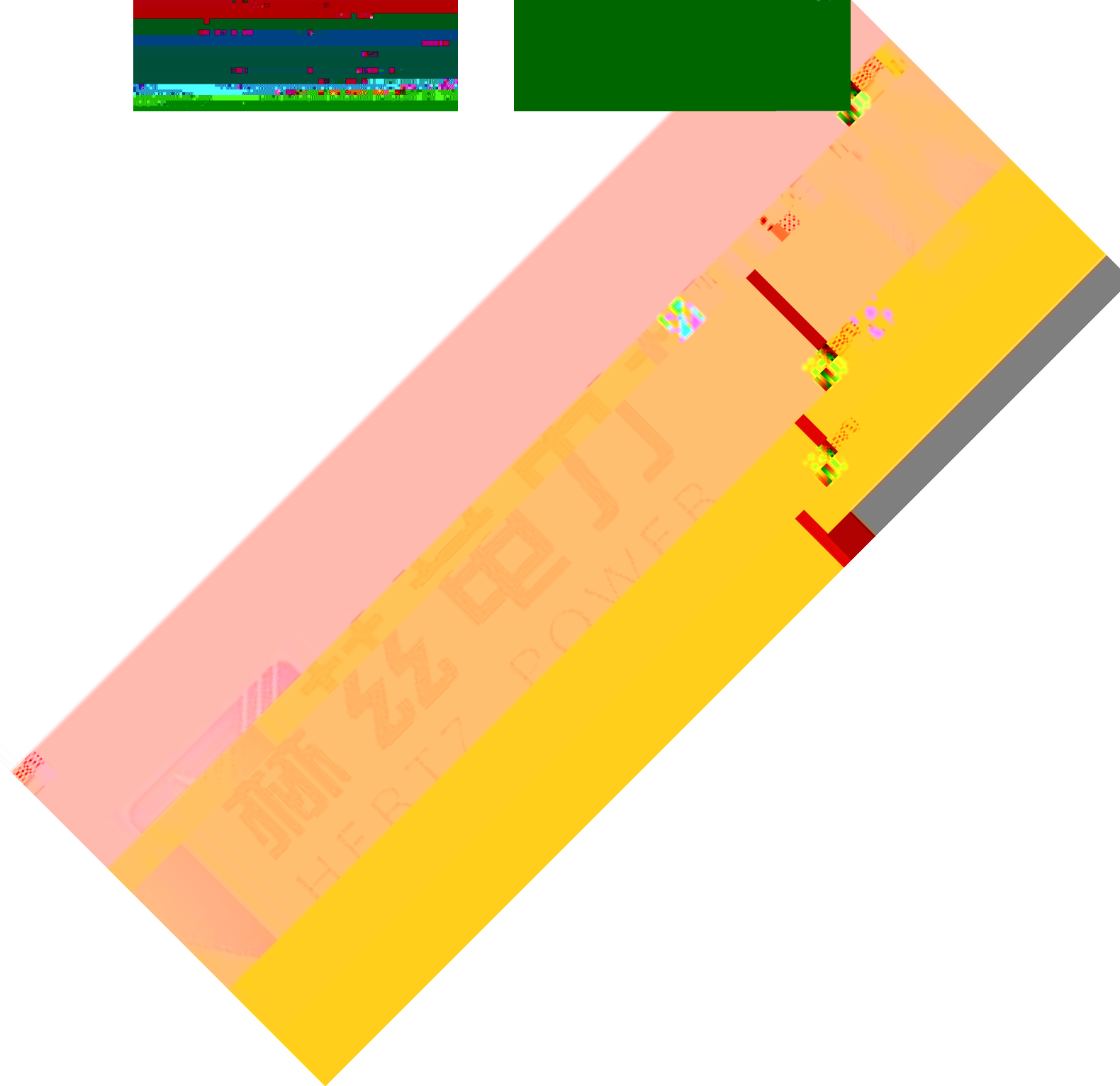
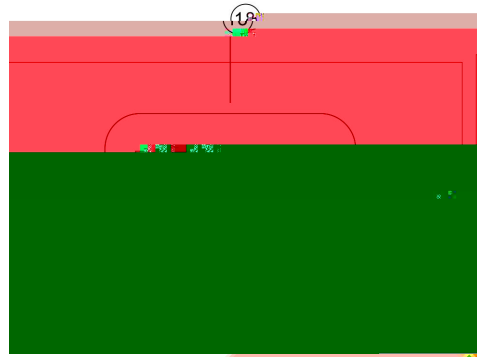
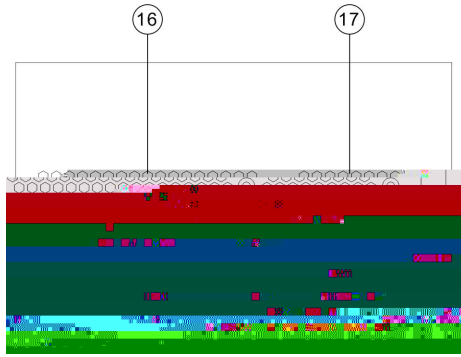

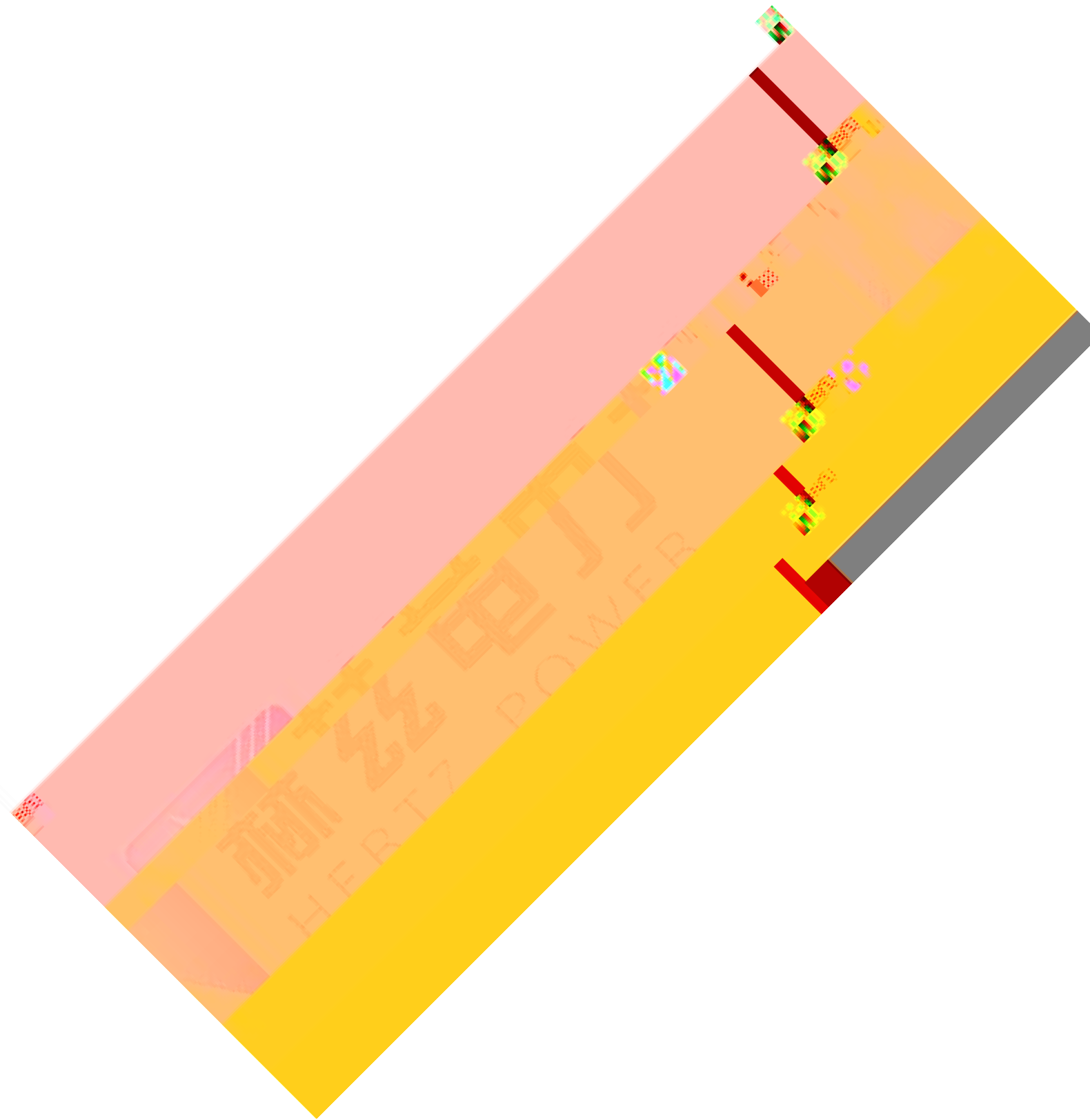

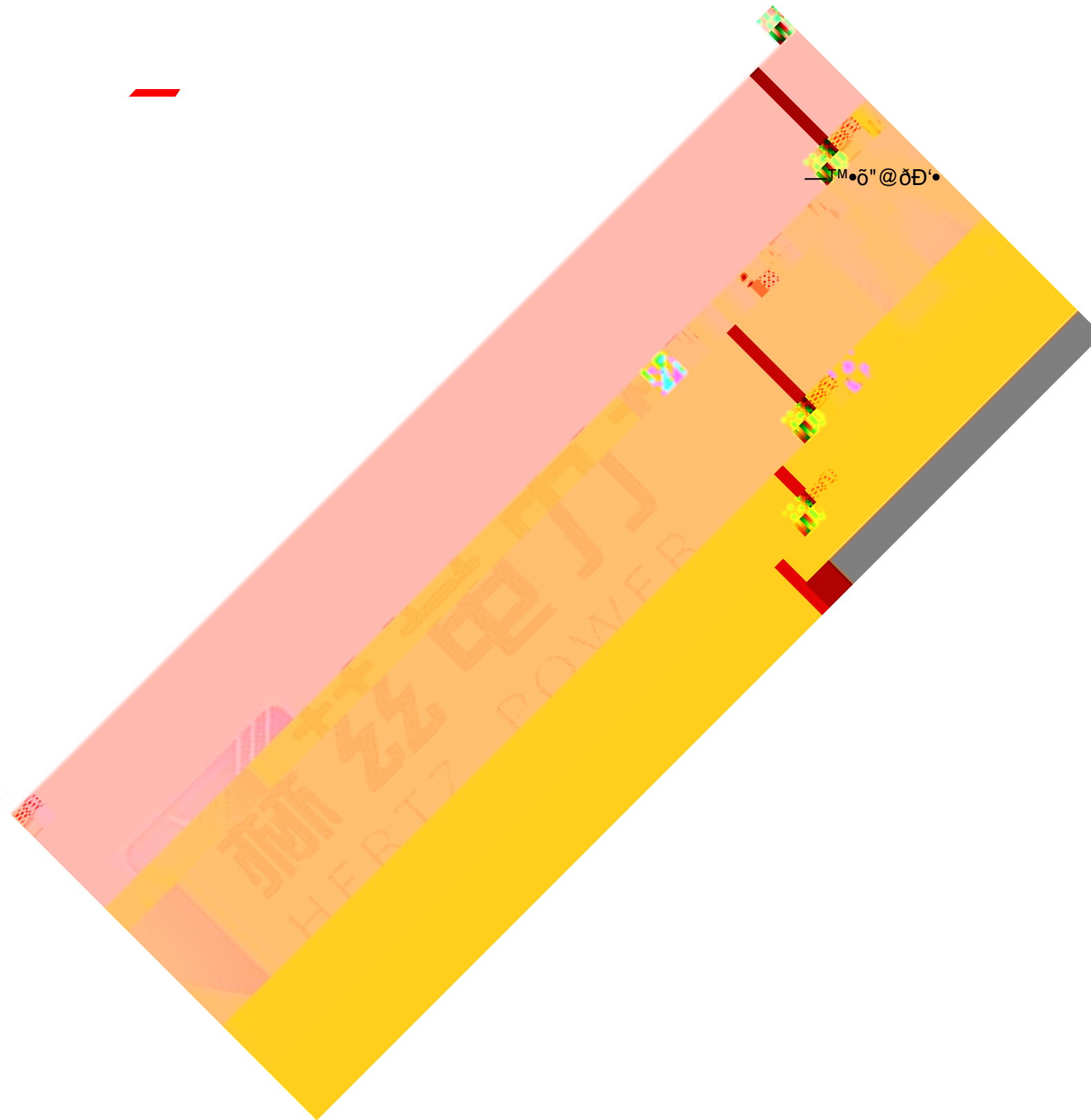

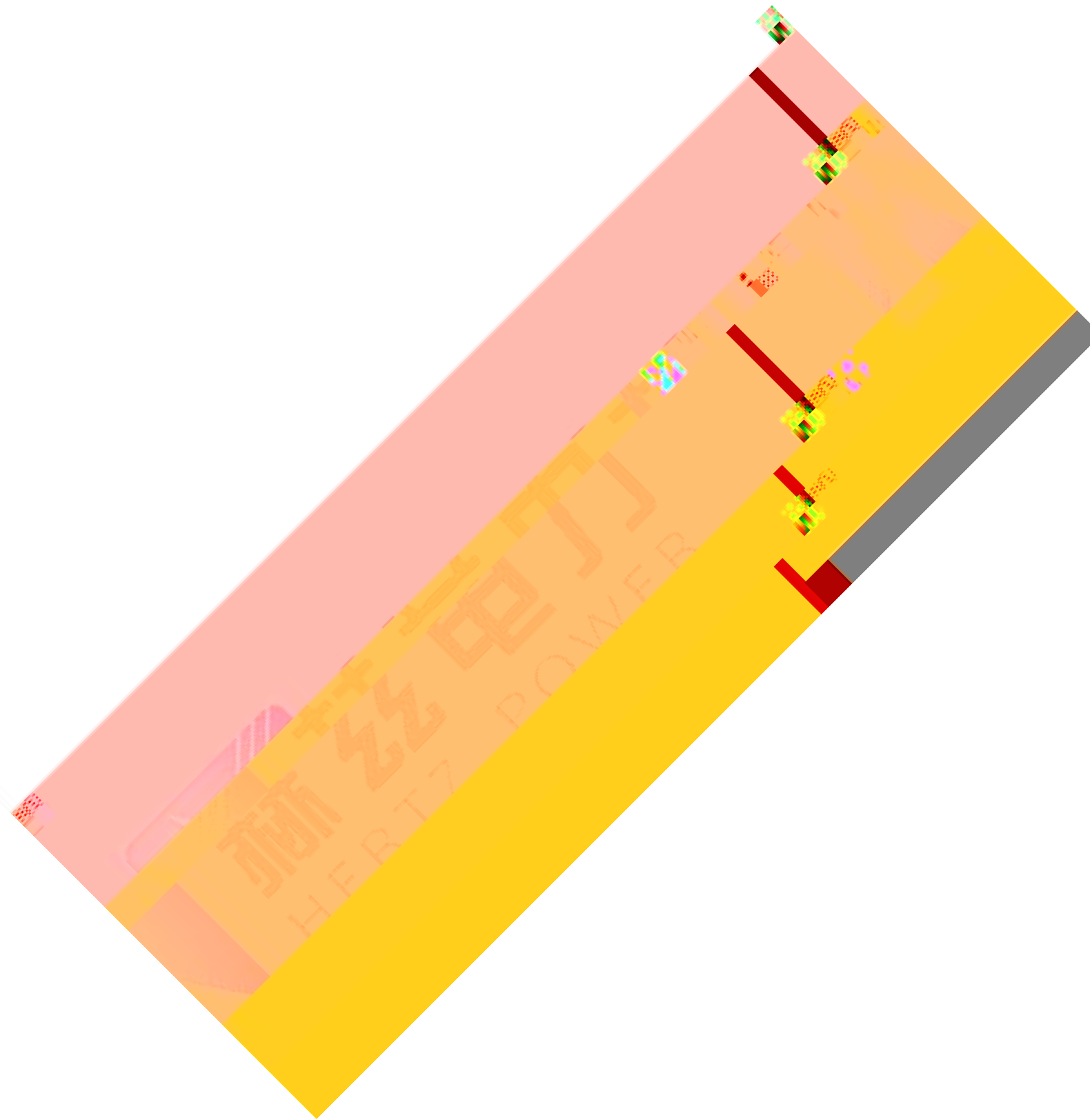

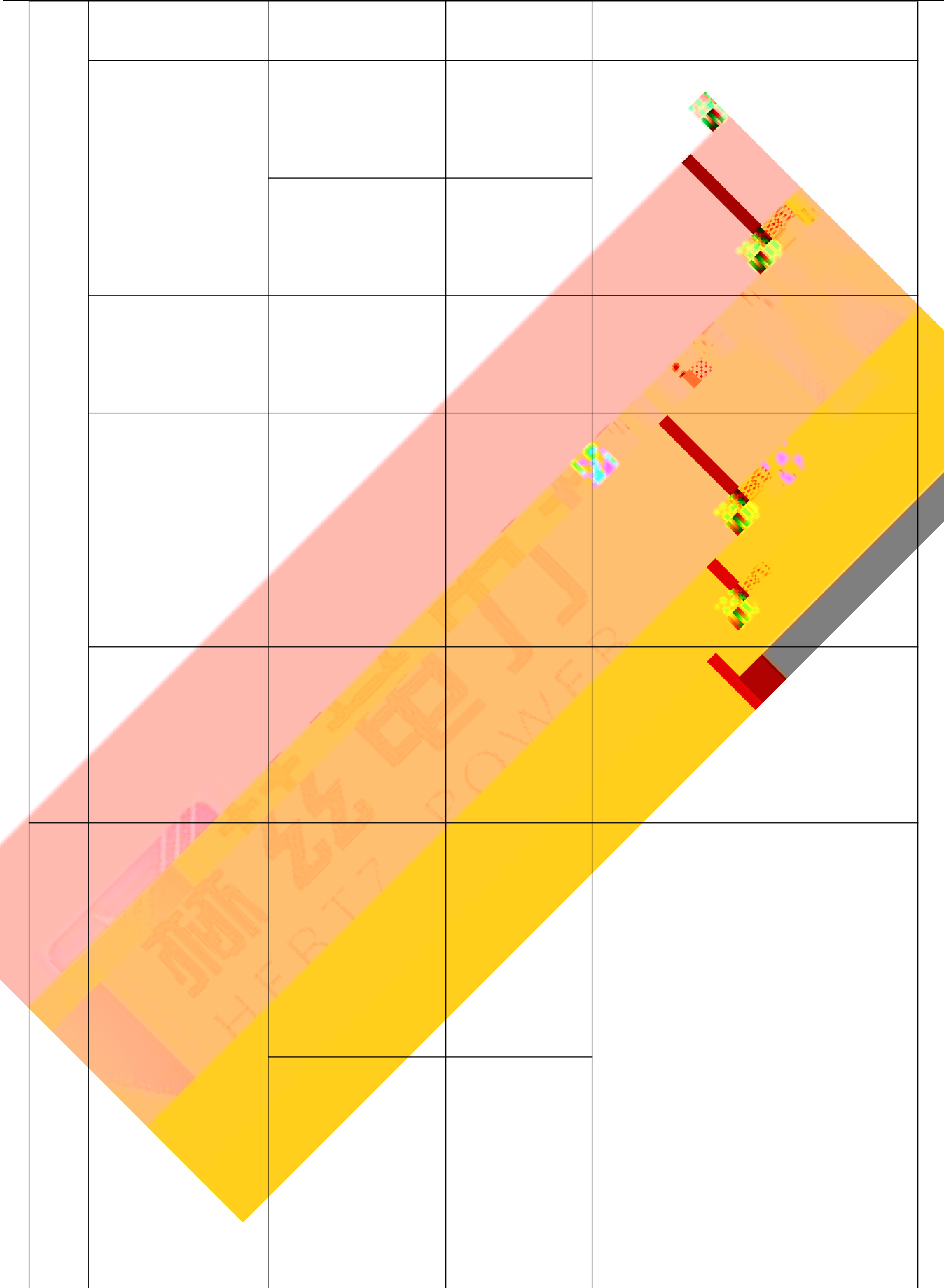

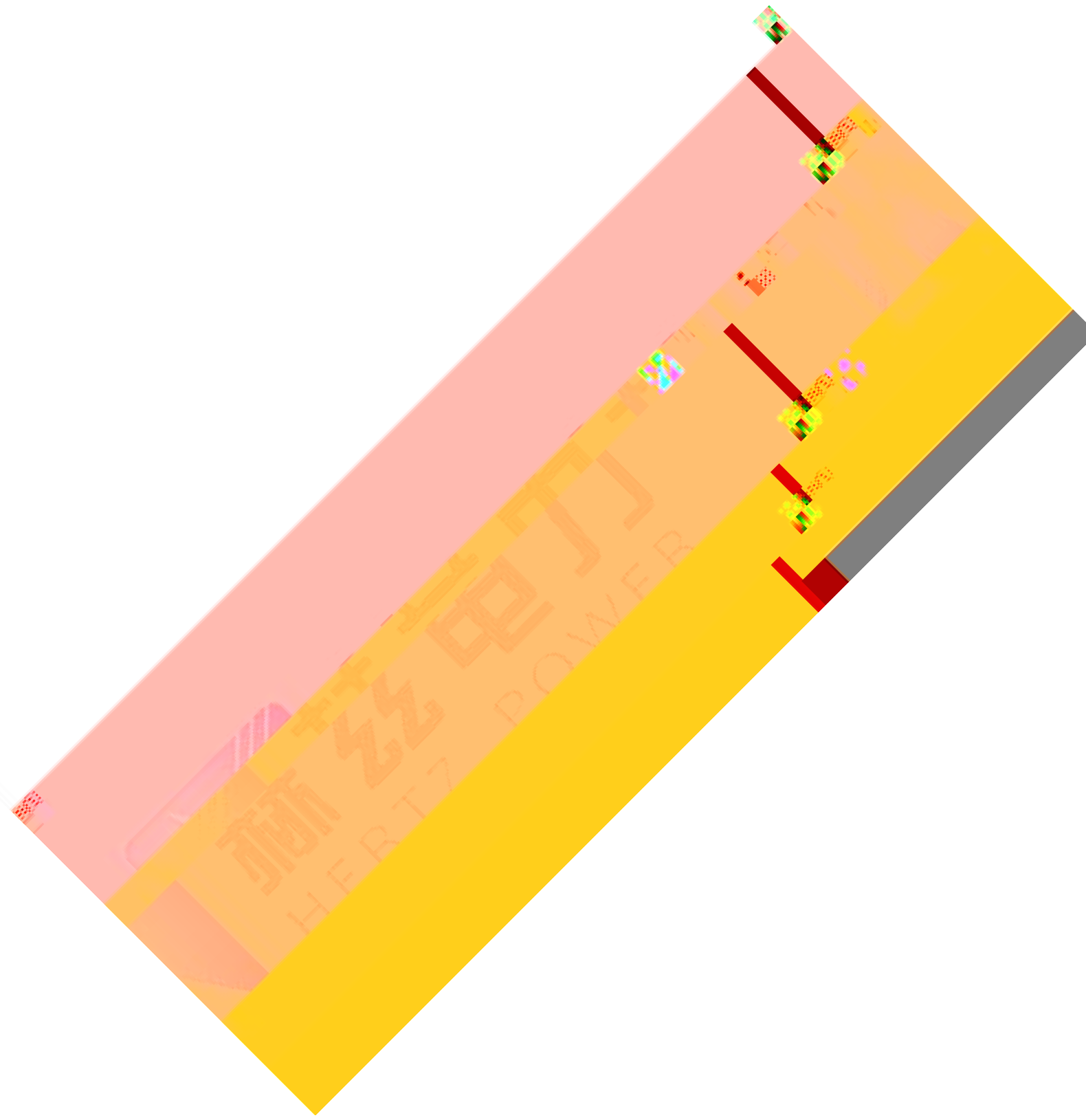

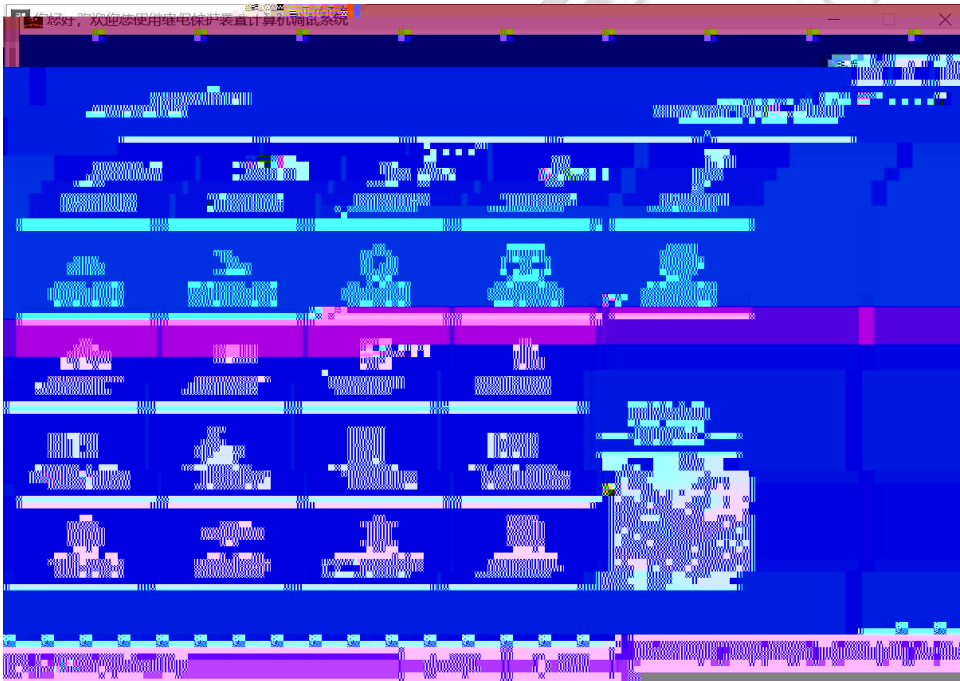



赫兹电力  
HERTZ POWER

产品宗旨：技术领先，质量可靠，轻便易用

服务宗旨：快速响应，**客户**到满意，**超过期**



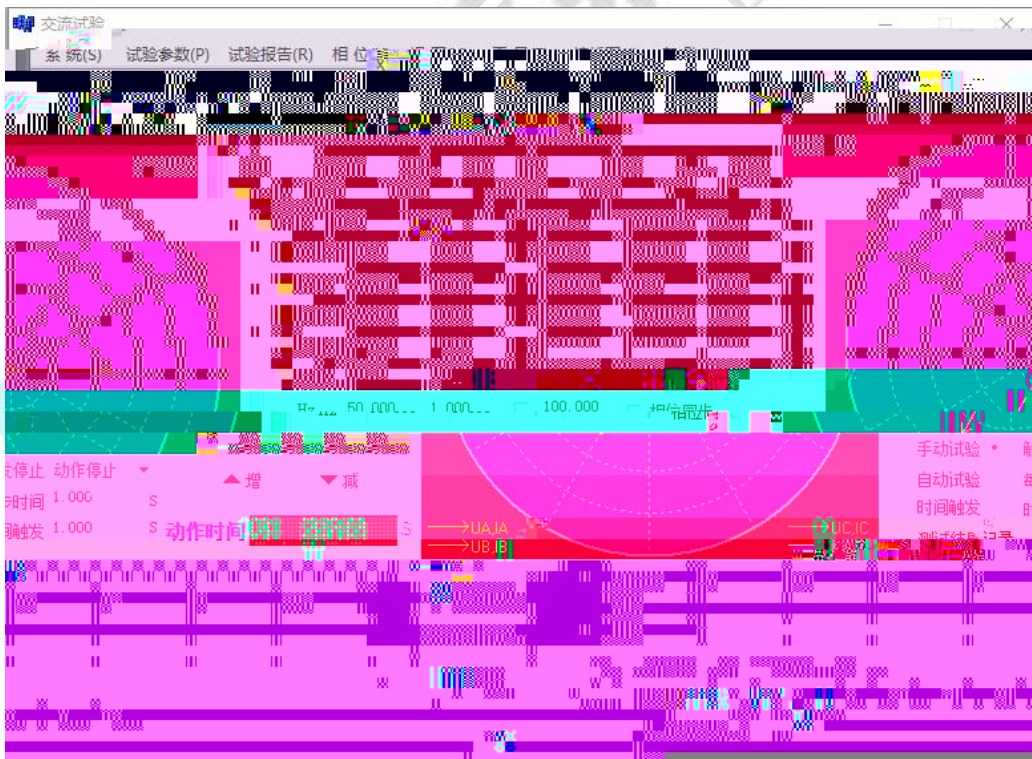
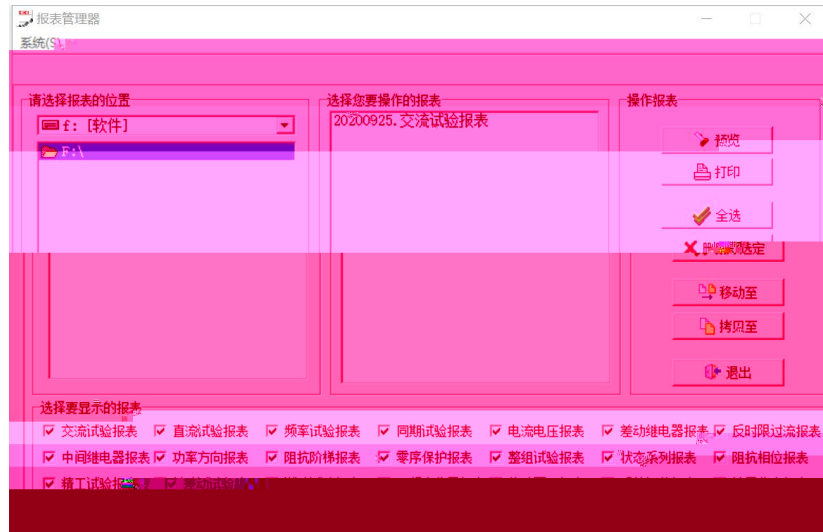



赫兹电力  
HERTZ POWER

产品宗旨：技术领先，质量可靠，轻便易用

服务宗旨：快速响应，**客户**到满意，**超过期**



赫兹电力  
HERTZ POWER



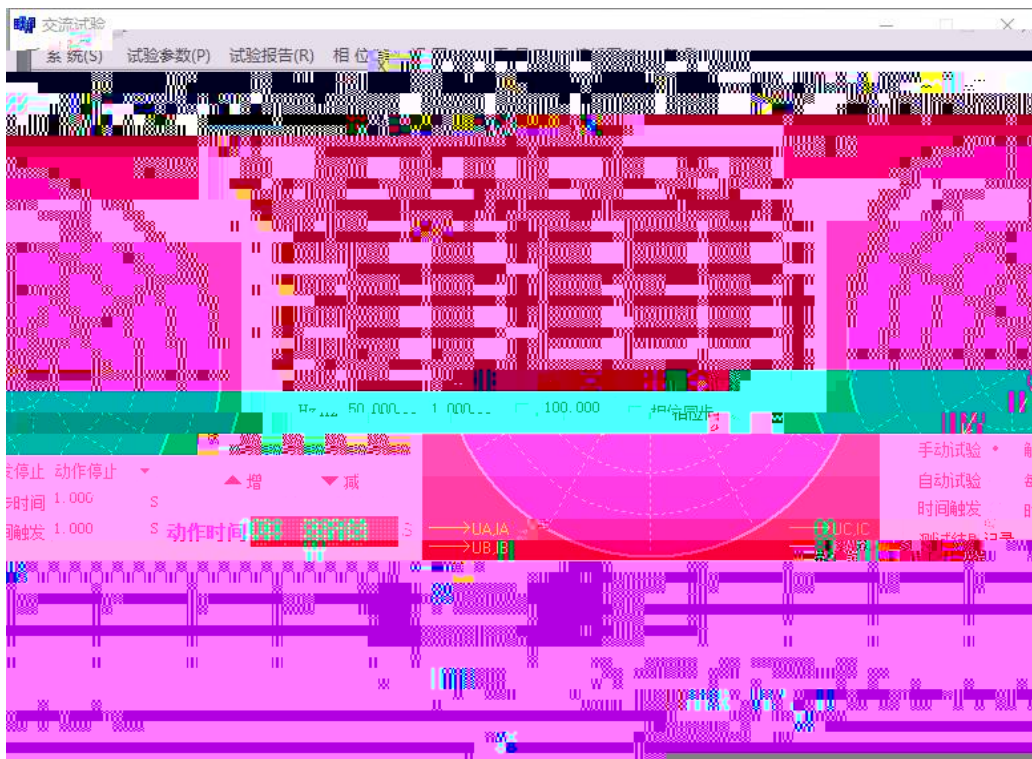





y#; (#;

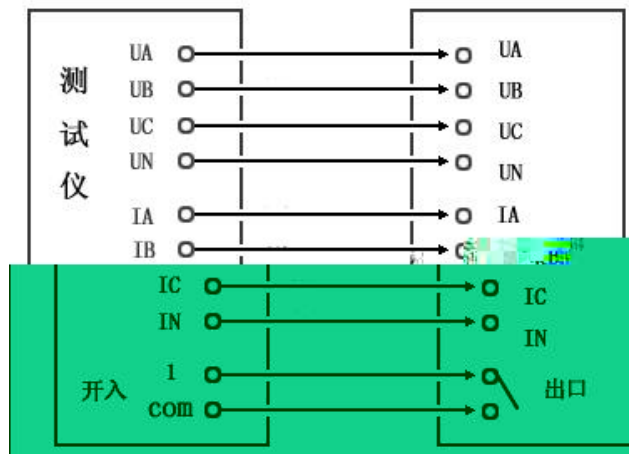

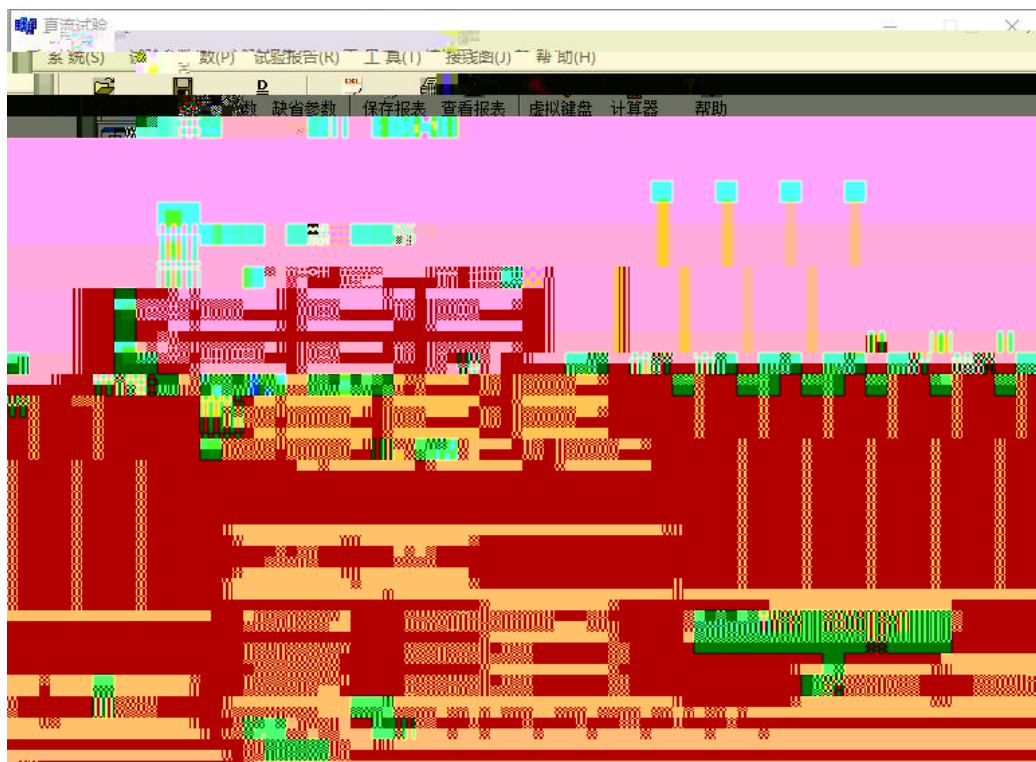

赫兹电力  
HERTZ POWER

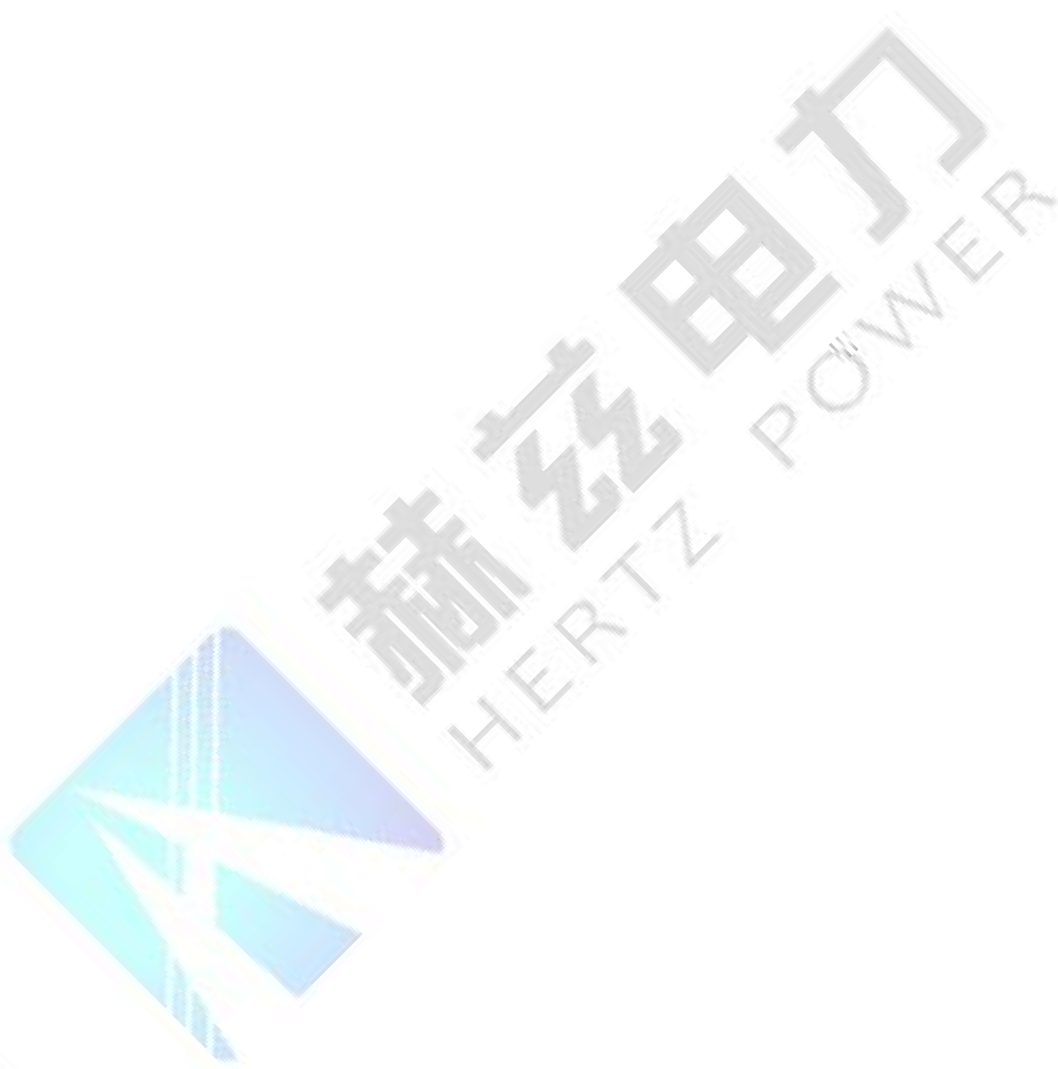
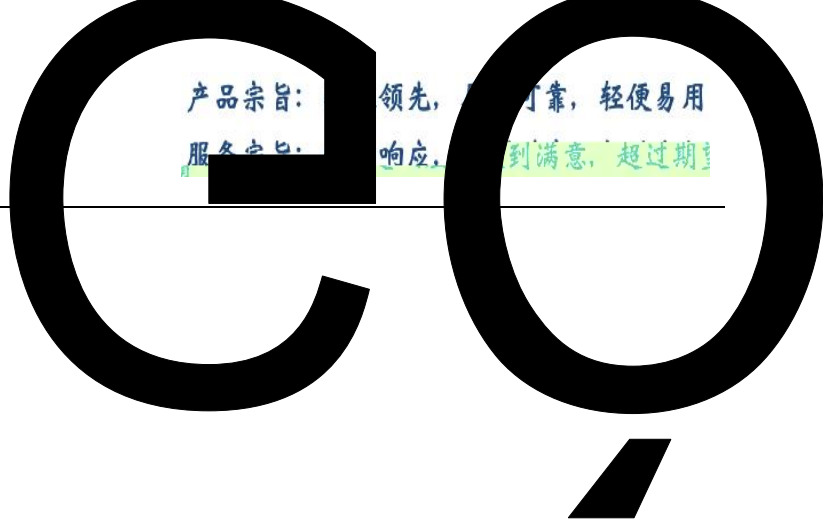

# Q&A



ä  
È ž ð  
> à È • È ž  
07

# 年 . C .

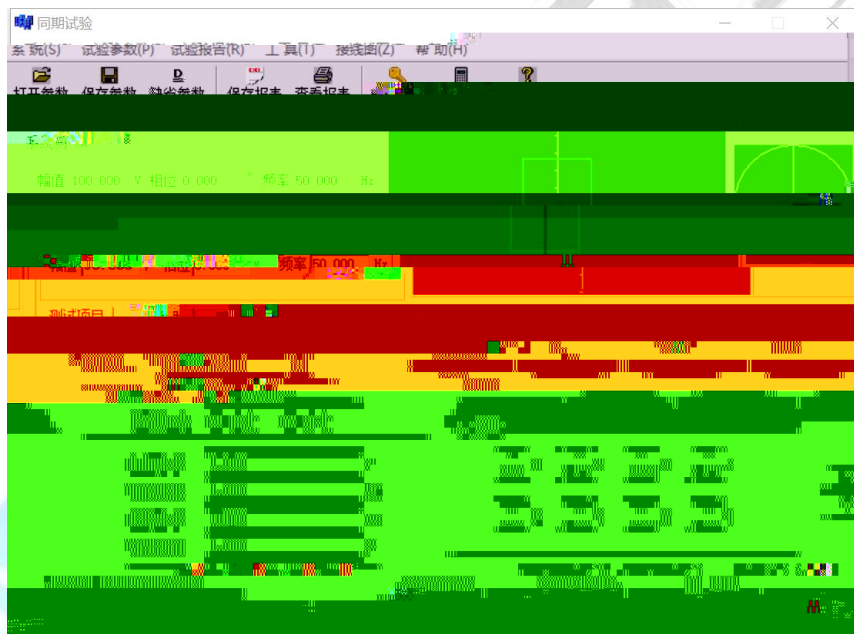
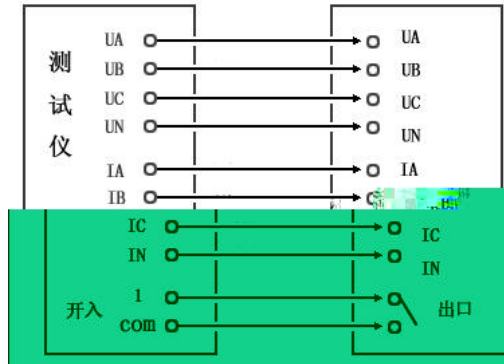

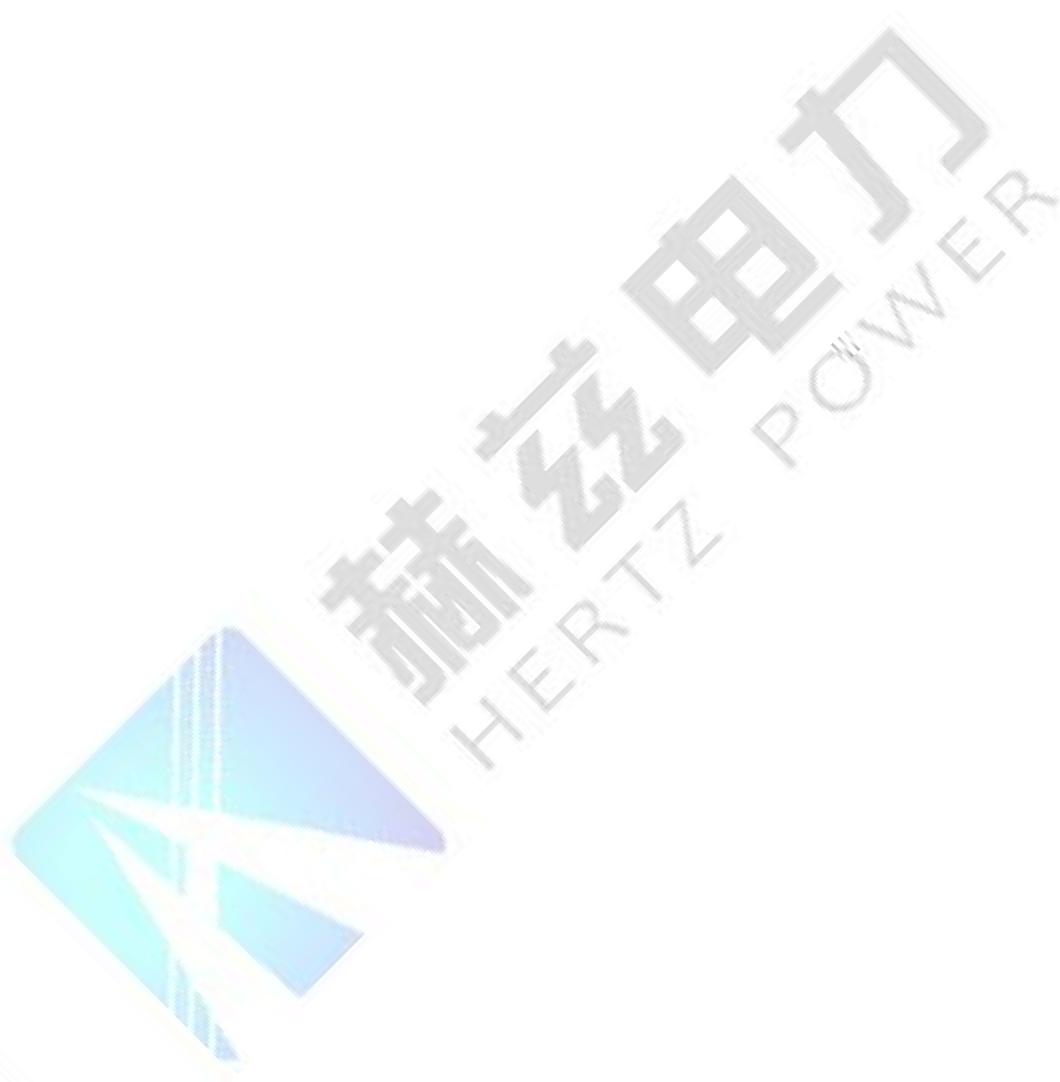

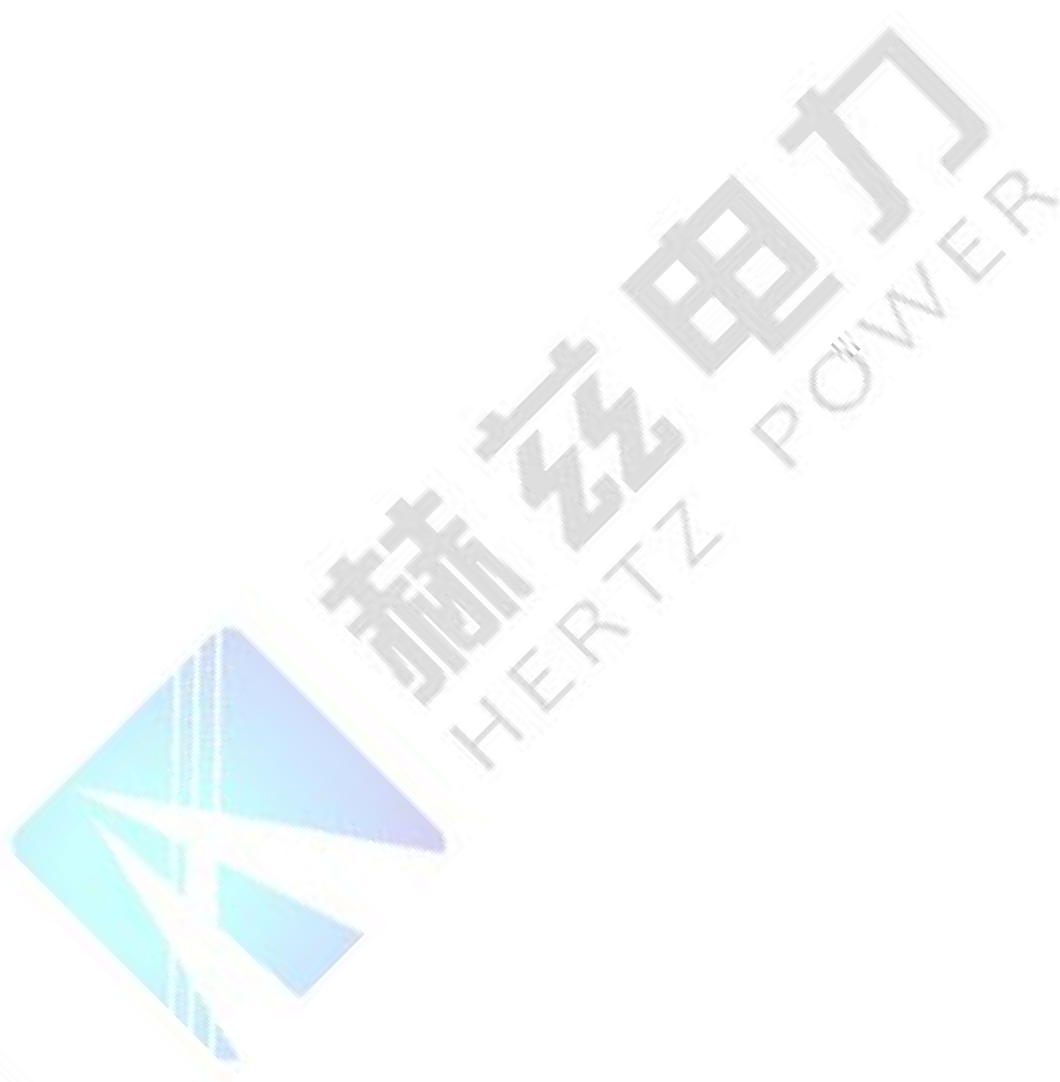



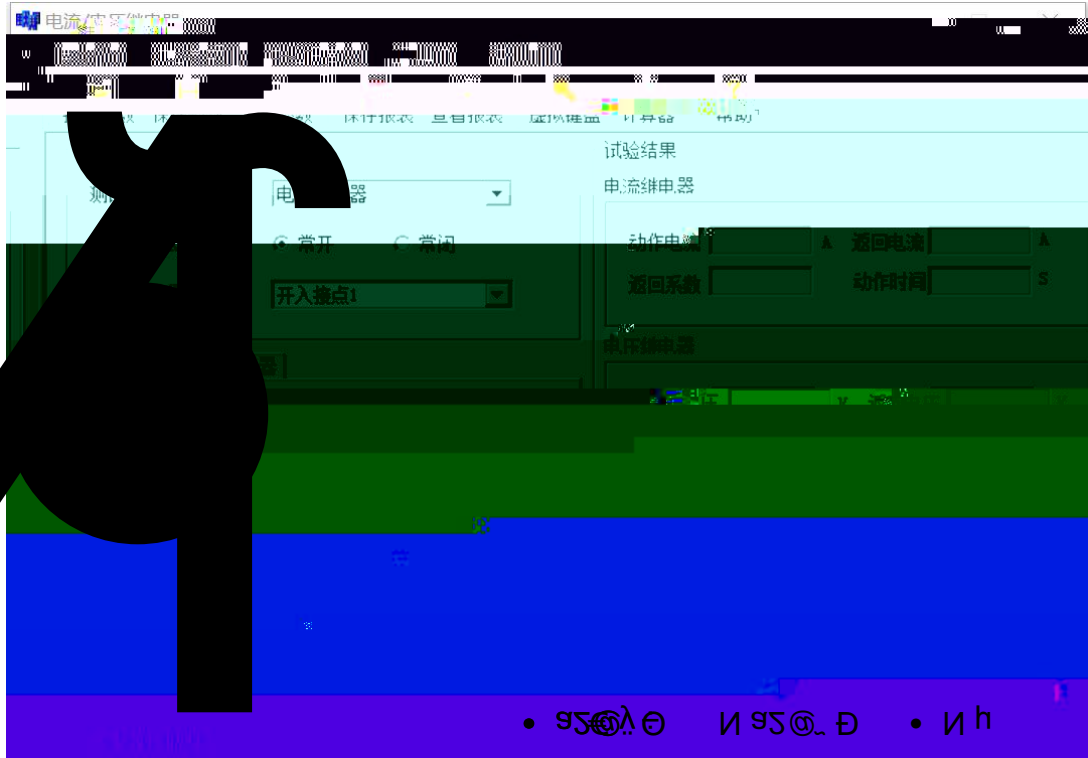

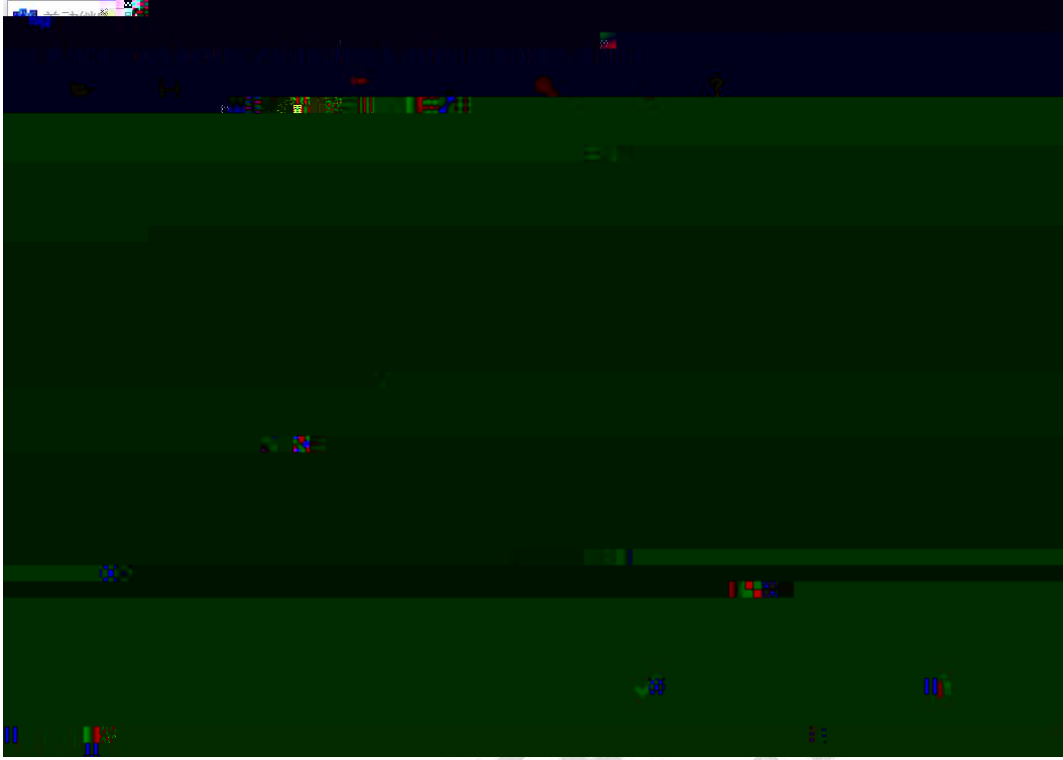

图形	结果
1	1.000
2	2.000
3	3.000
4	4.000
5	5.000
6	6.000
7	7.000
8	8.000
9	9.000
10	10.000

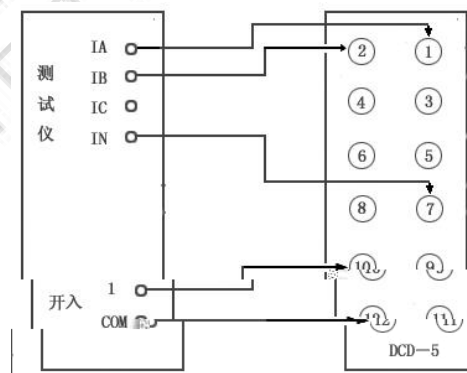
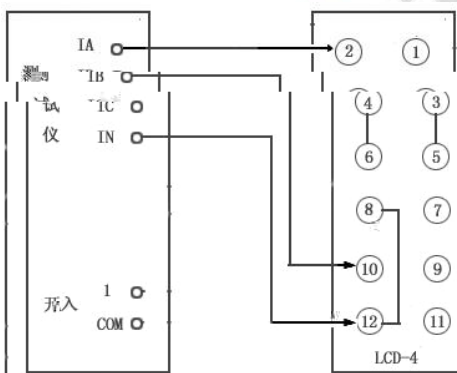

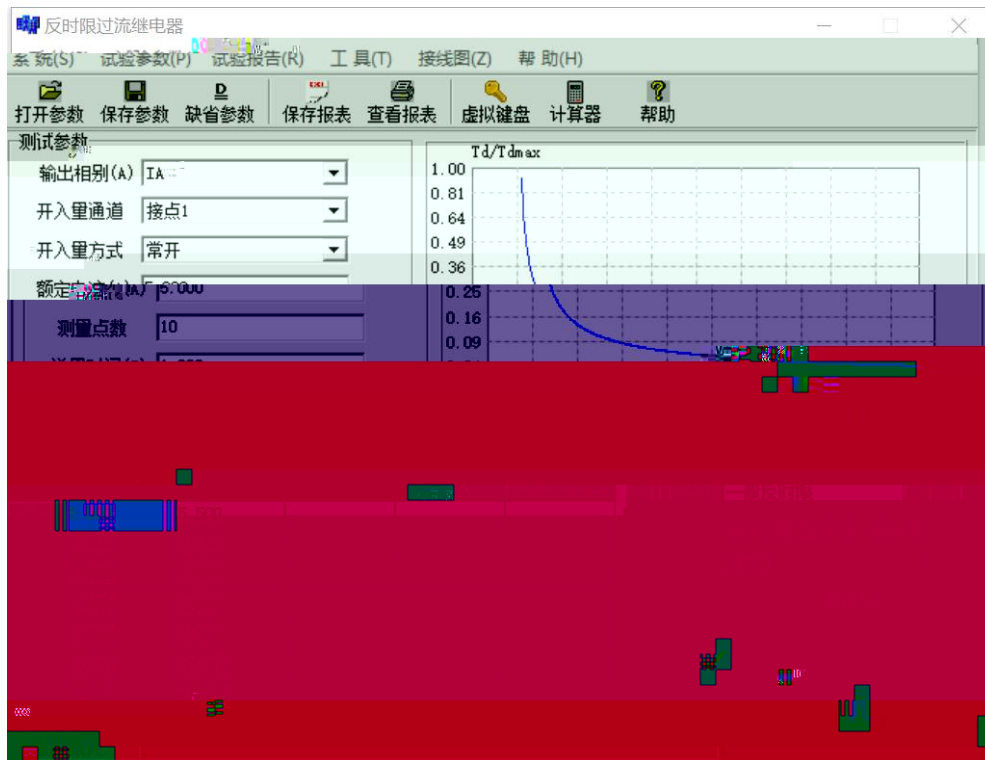







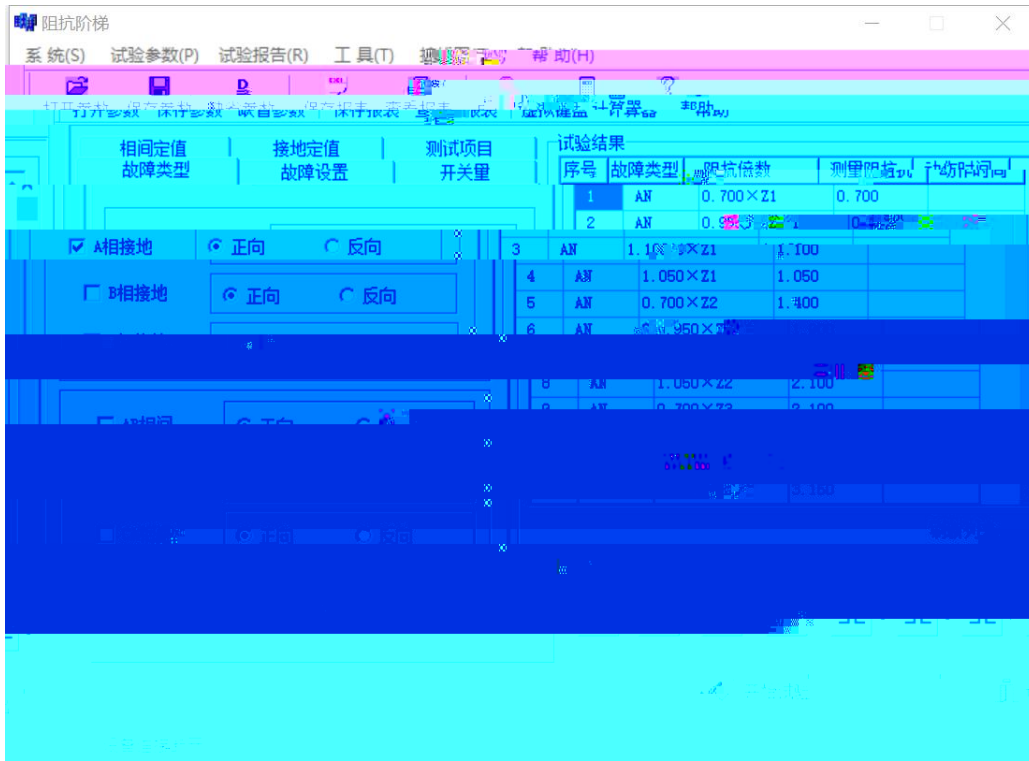

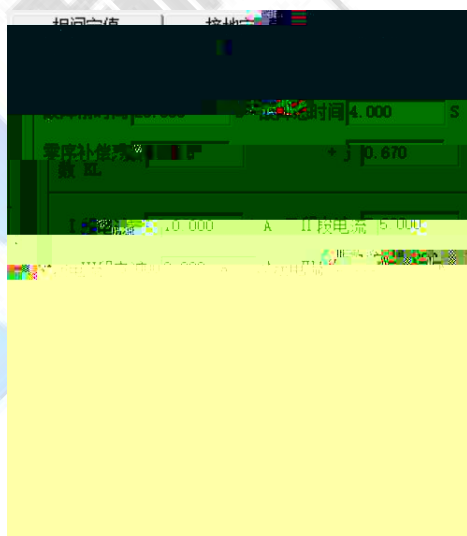
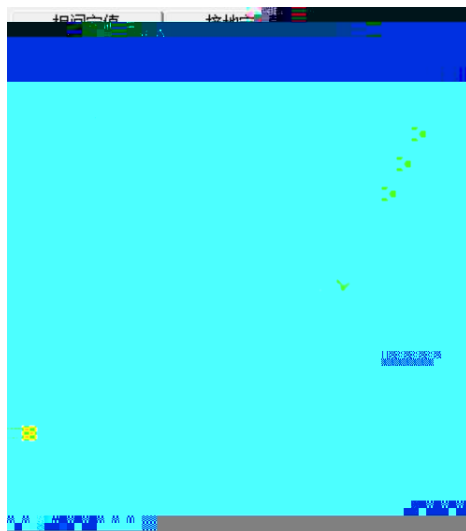

赫兹电力  
HERTZ POWER

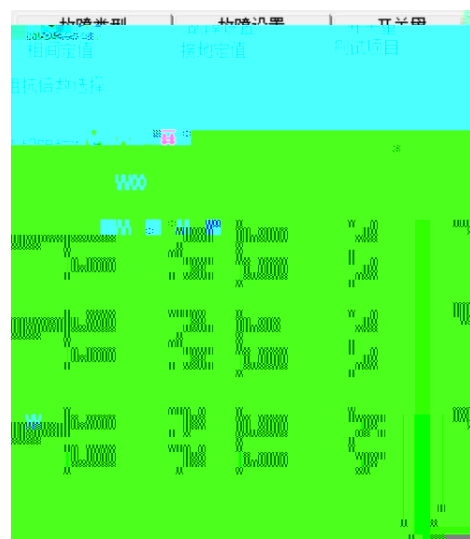

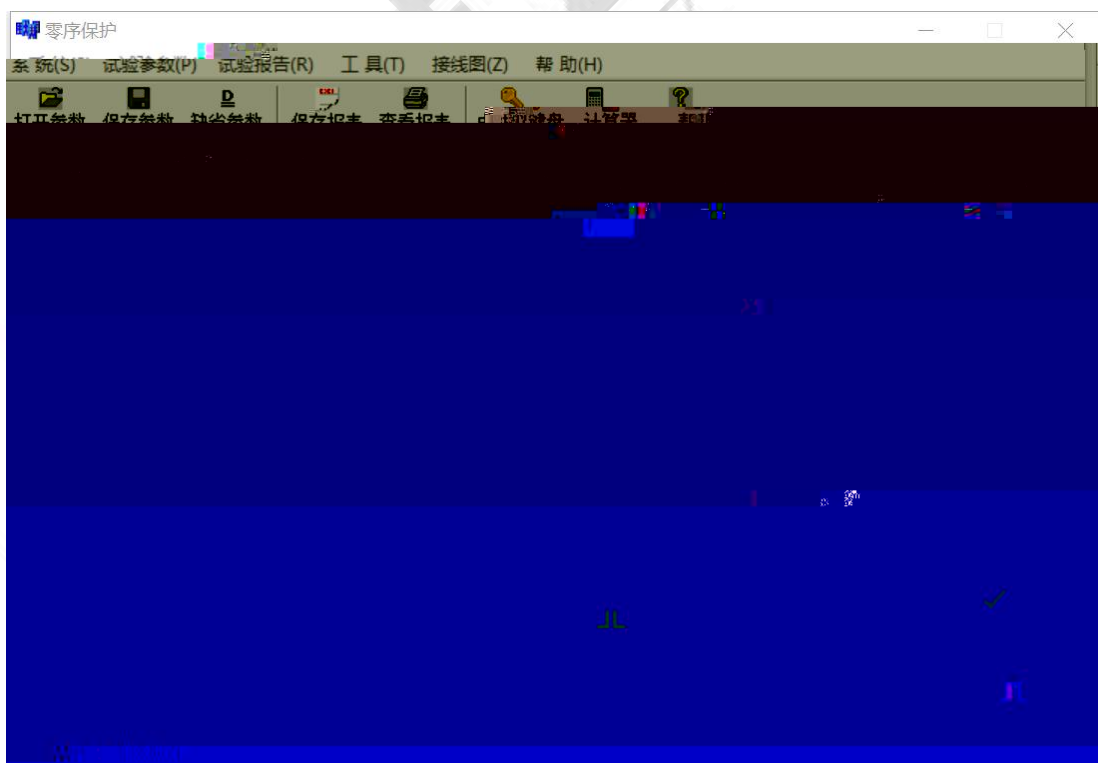
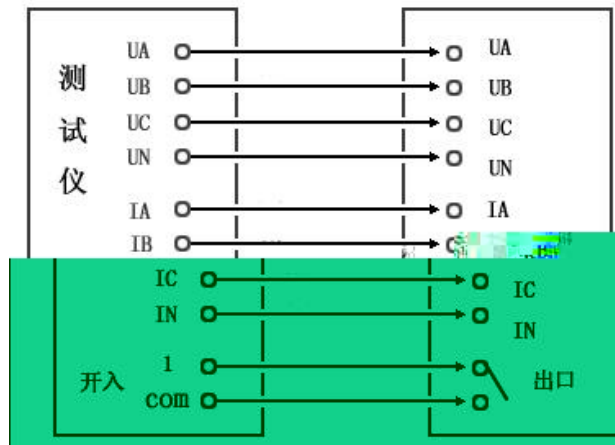

# 问 答

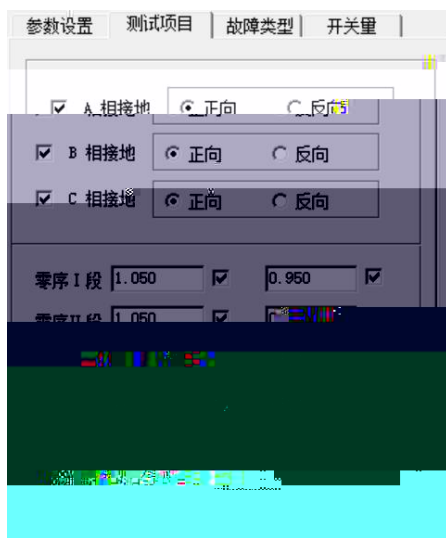

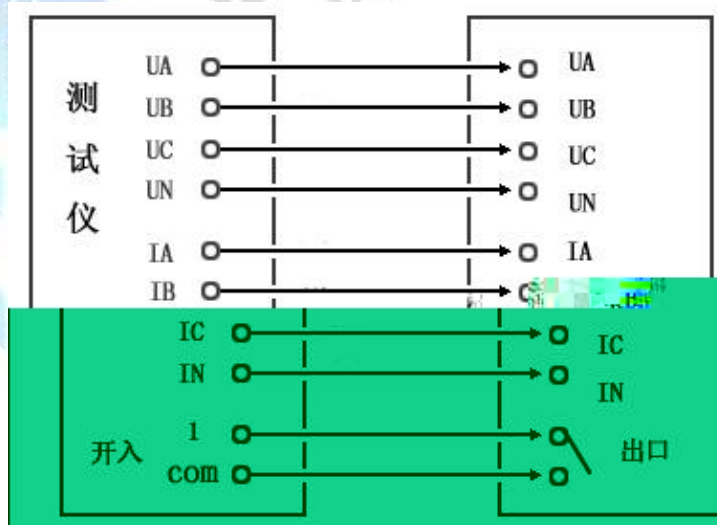
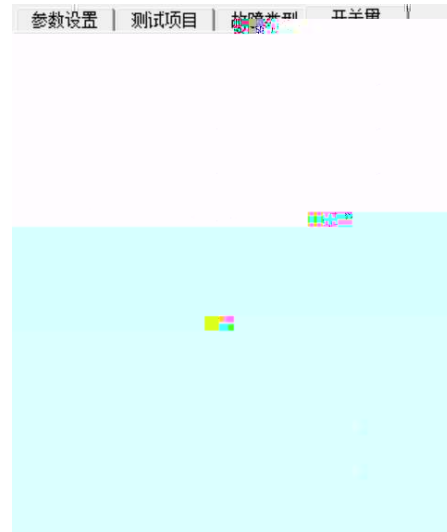
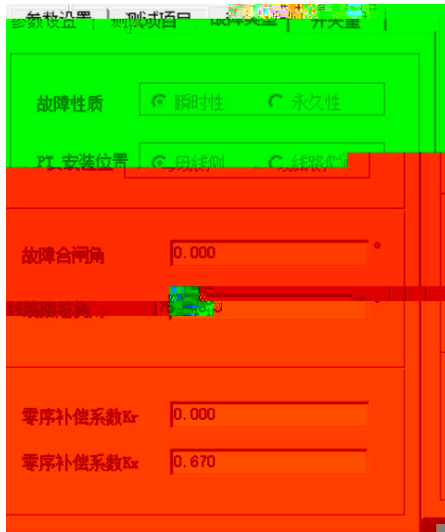

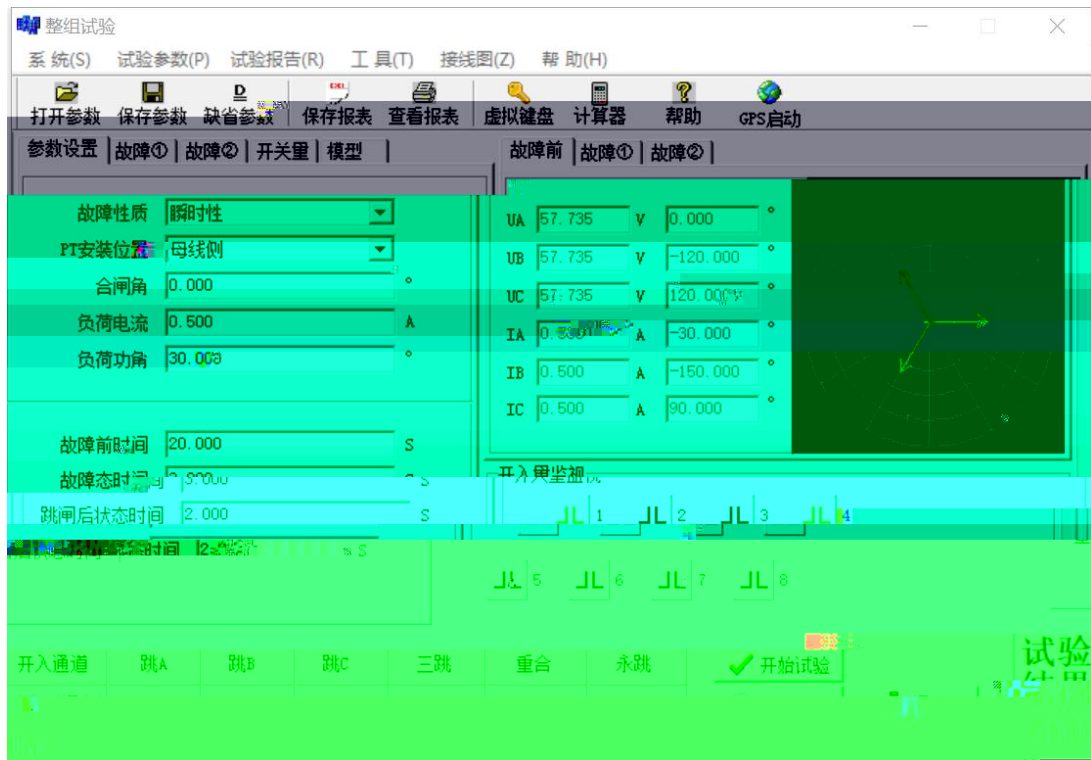



赫兹电力  
HERTZ POWER

产品宗旨：技术领先，质量可靠，轻便易用

服务宗旨：快速响应，**客户**到满意，**超过期**



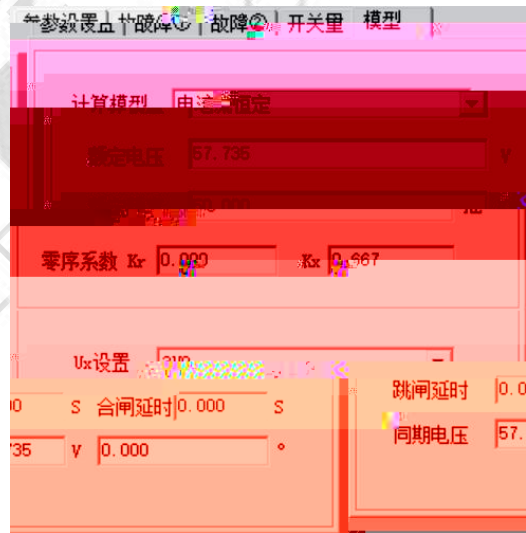



赫兹电力  
HERTZ POWER

产品宗旨：技术领先，质量可靠，轻便易用

服务宗旨：快速响应，**客户**到满意，**超过期**





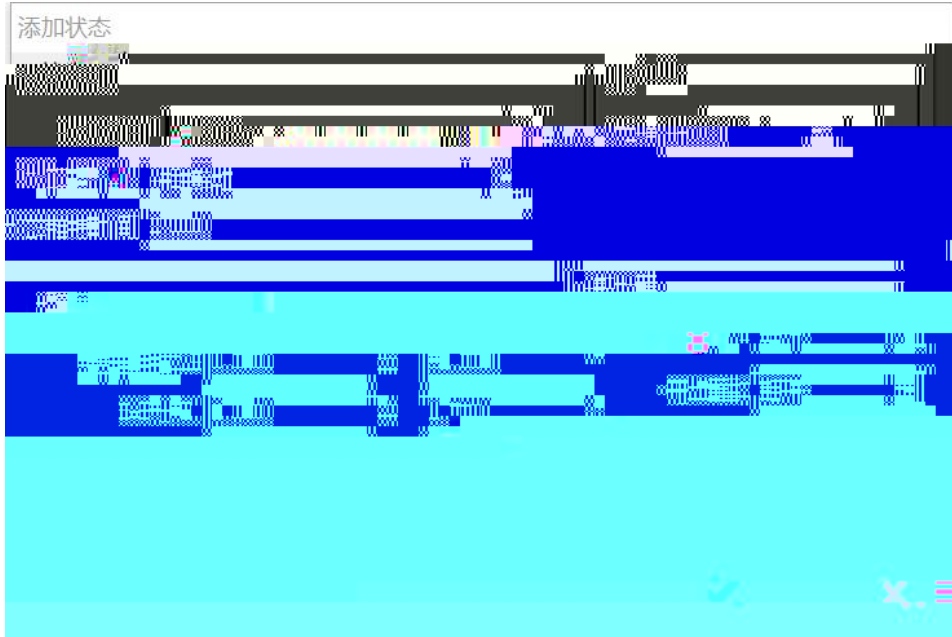

赫兹  
HERTZ POWER

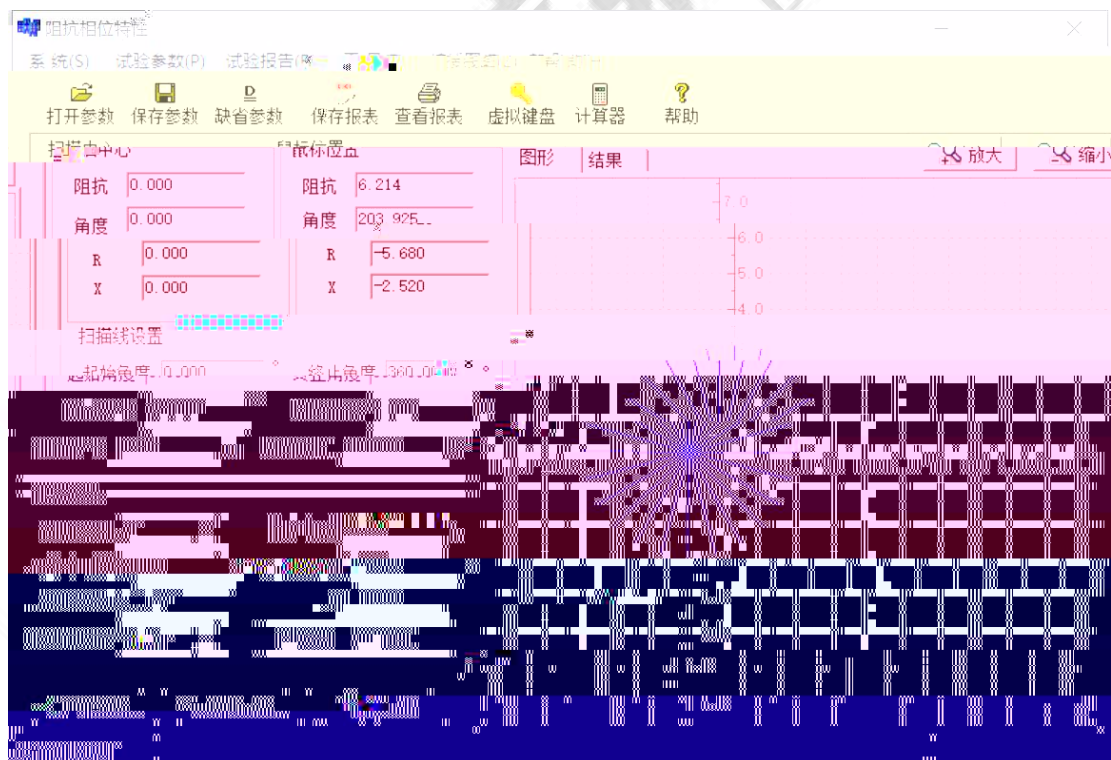
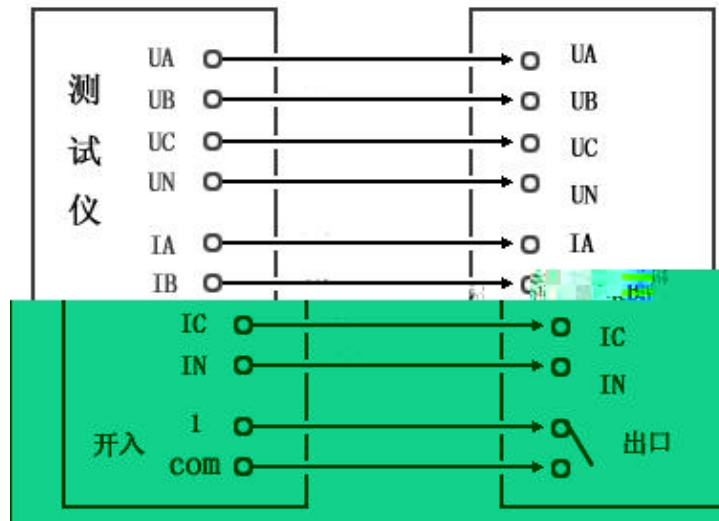



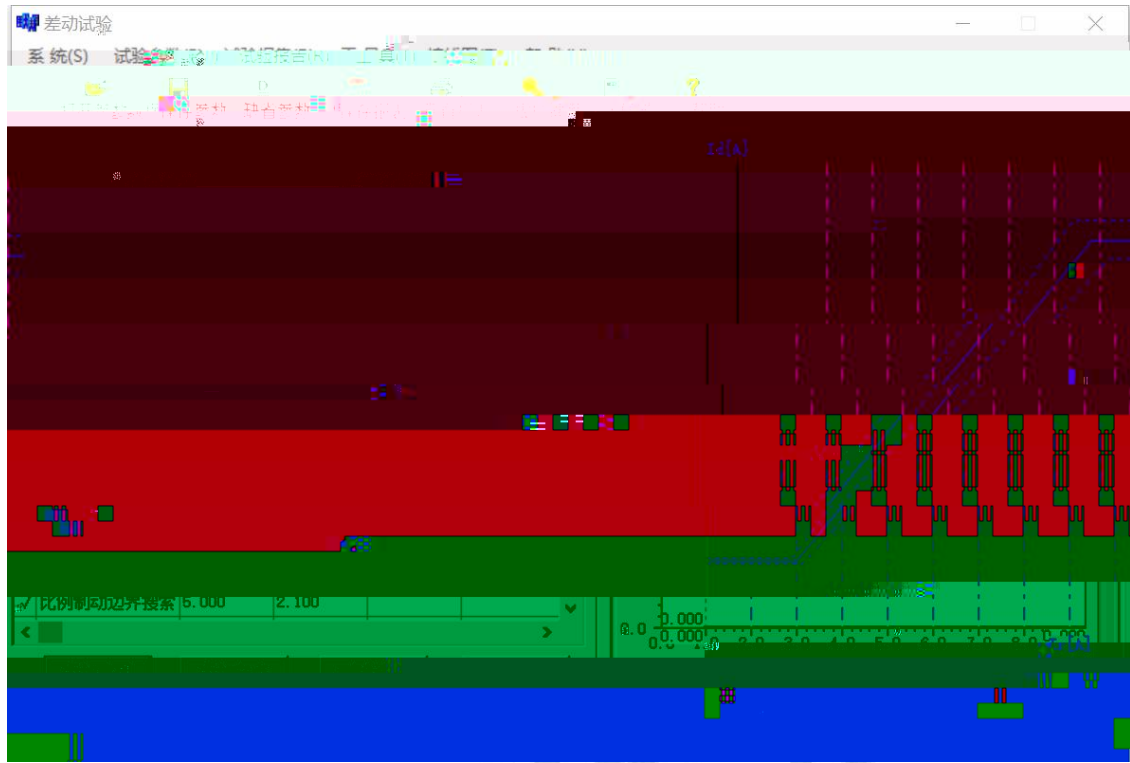



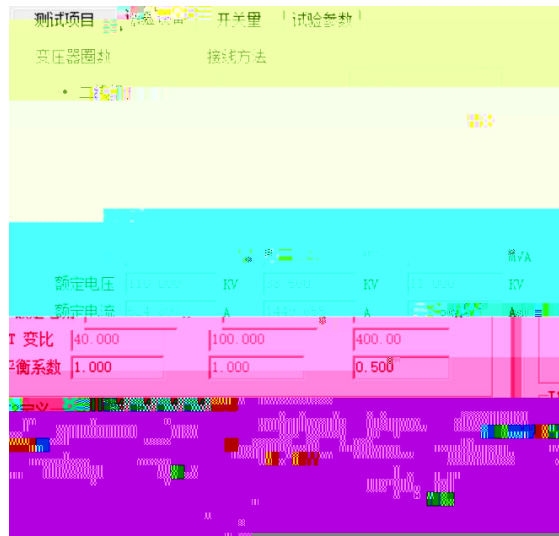

赫兹电力  
HERTZ POWER



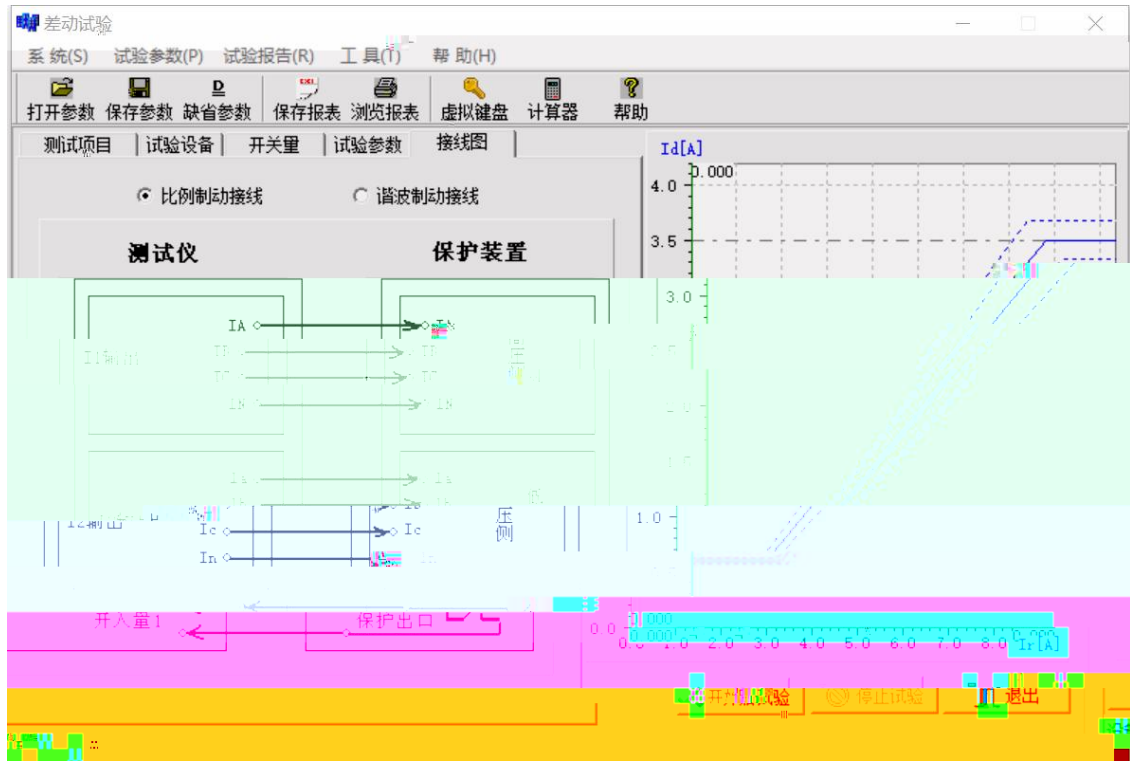

赫兹电力  
HERTZ POWER

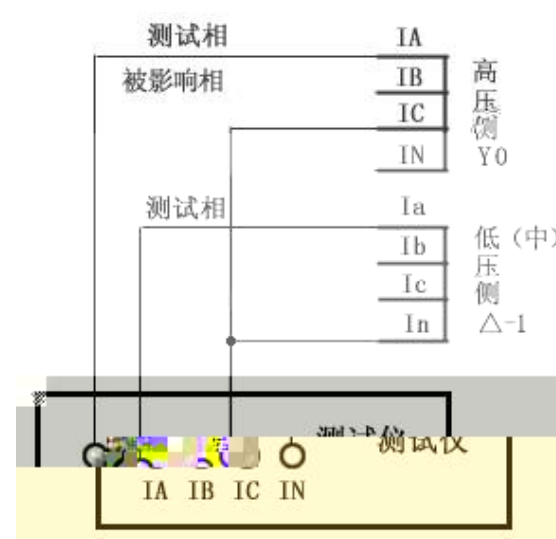
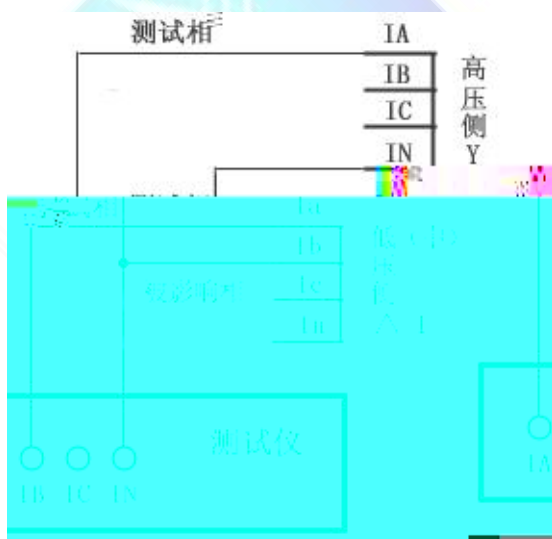
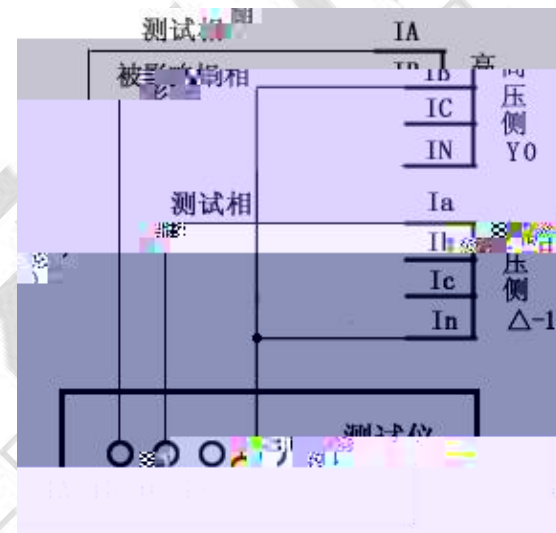
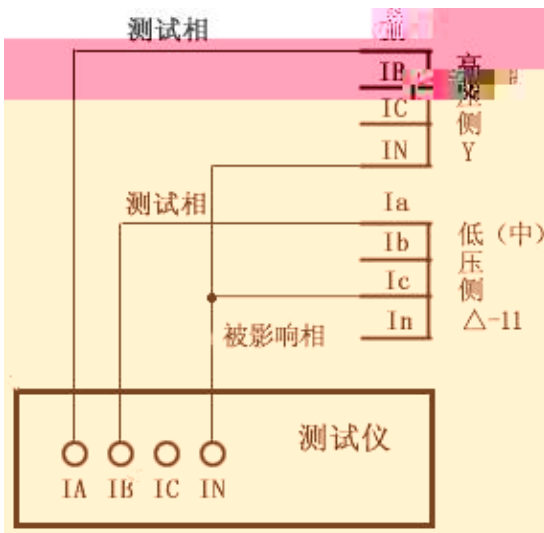
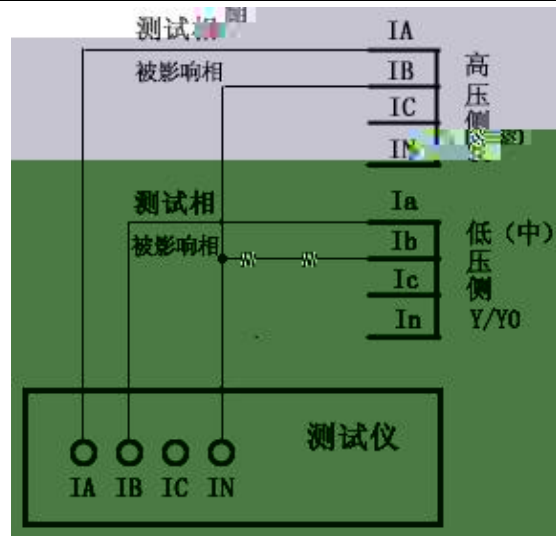
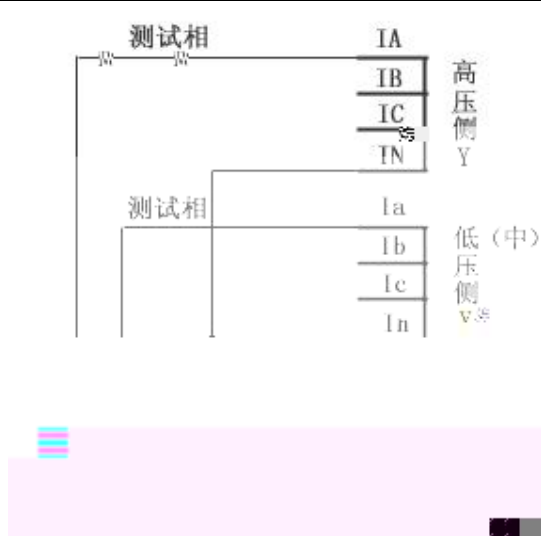

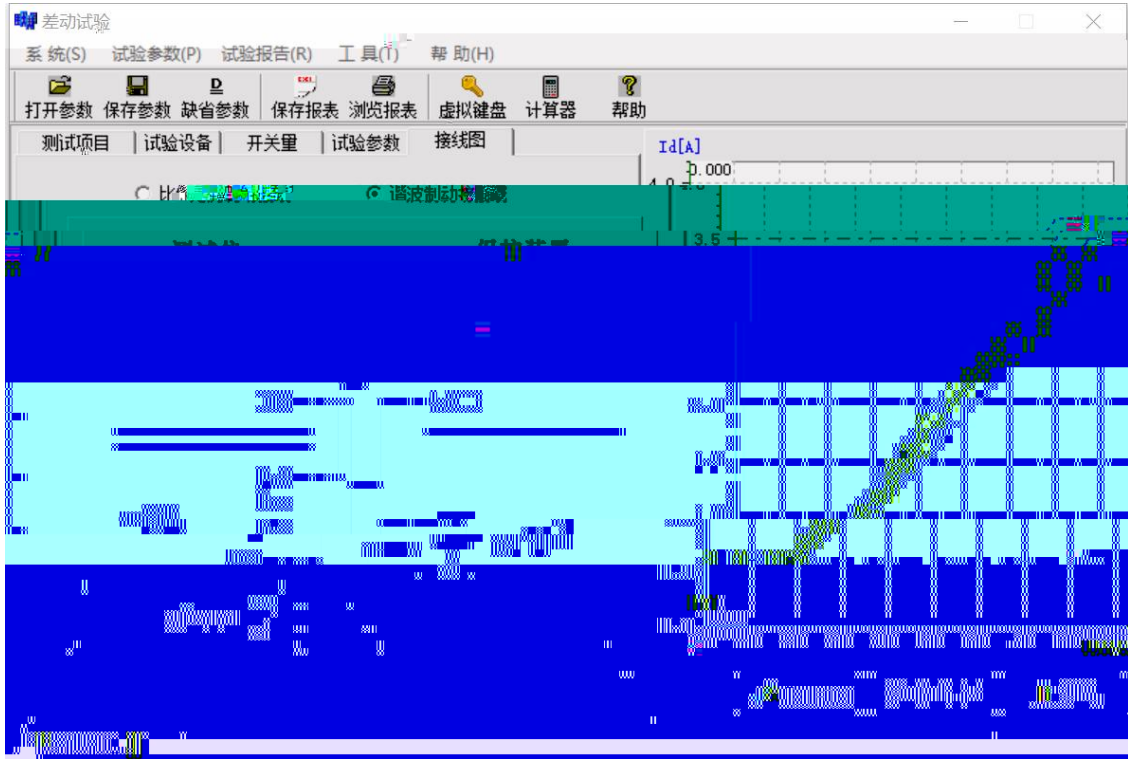

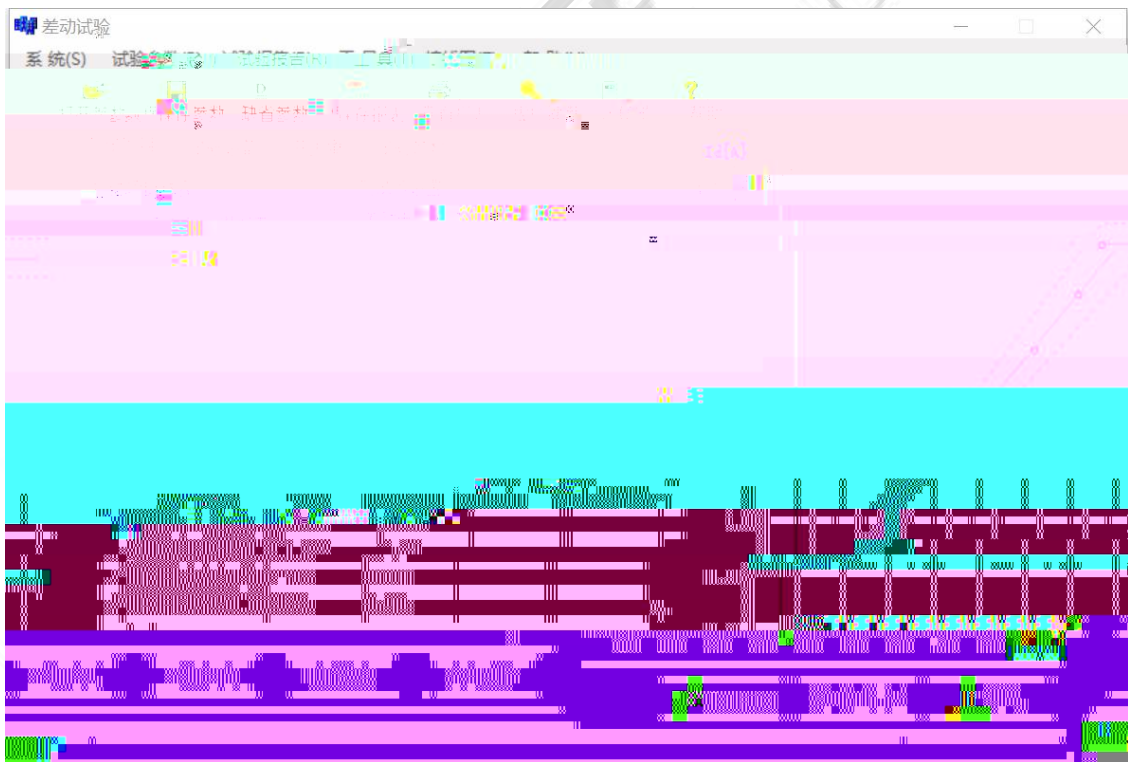
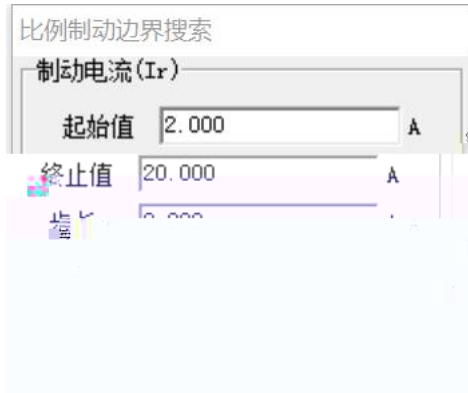

赫兹  
HERTZ P



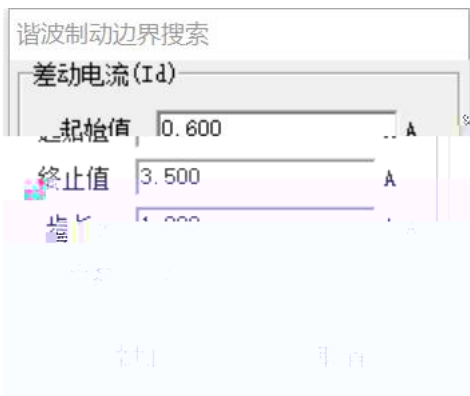

赫兹电力  
HERTZ POWER



赫兹电力  
HERTZ POWER

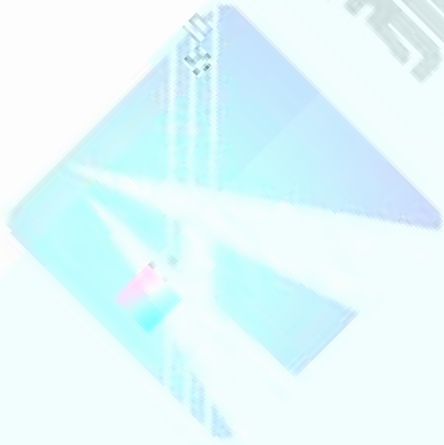



赫兹电力  
HERTZ POWER



赫兹电力  
HERTZ POWER

产品宗旨：技术领先，质量可靠，轻便易用

服务宗旨：快速响应，**客户**到满意，**超过期**

赫兹电力  
HERTZ POWER

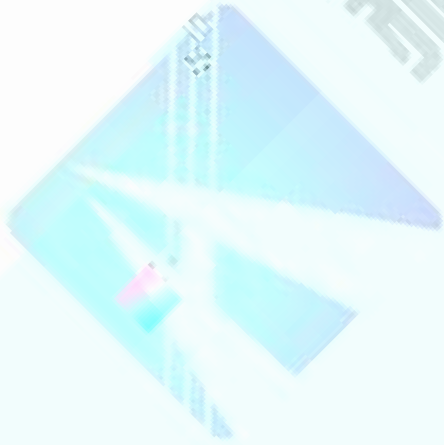



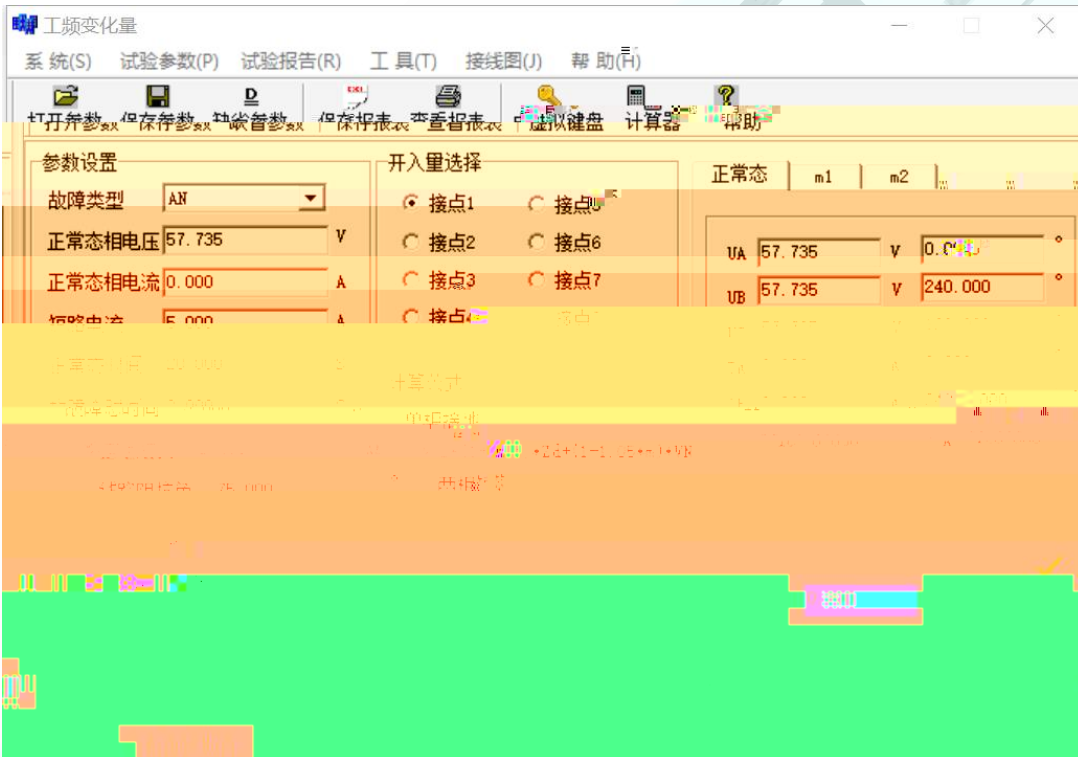
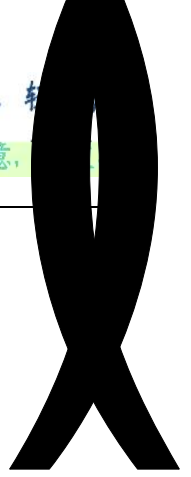

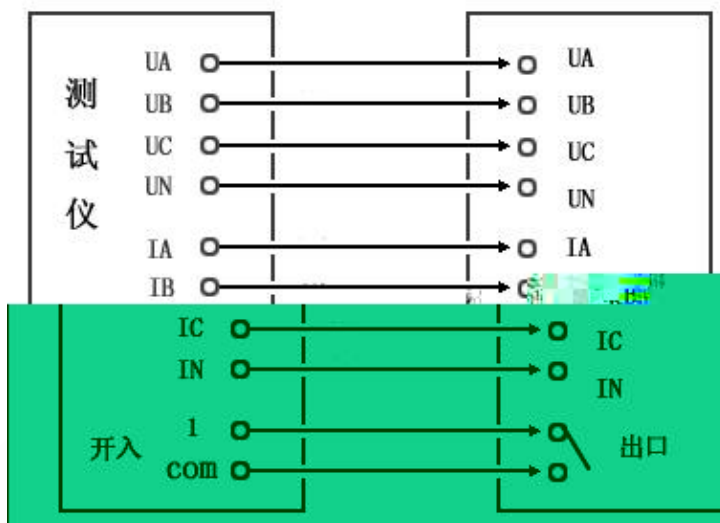

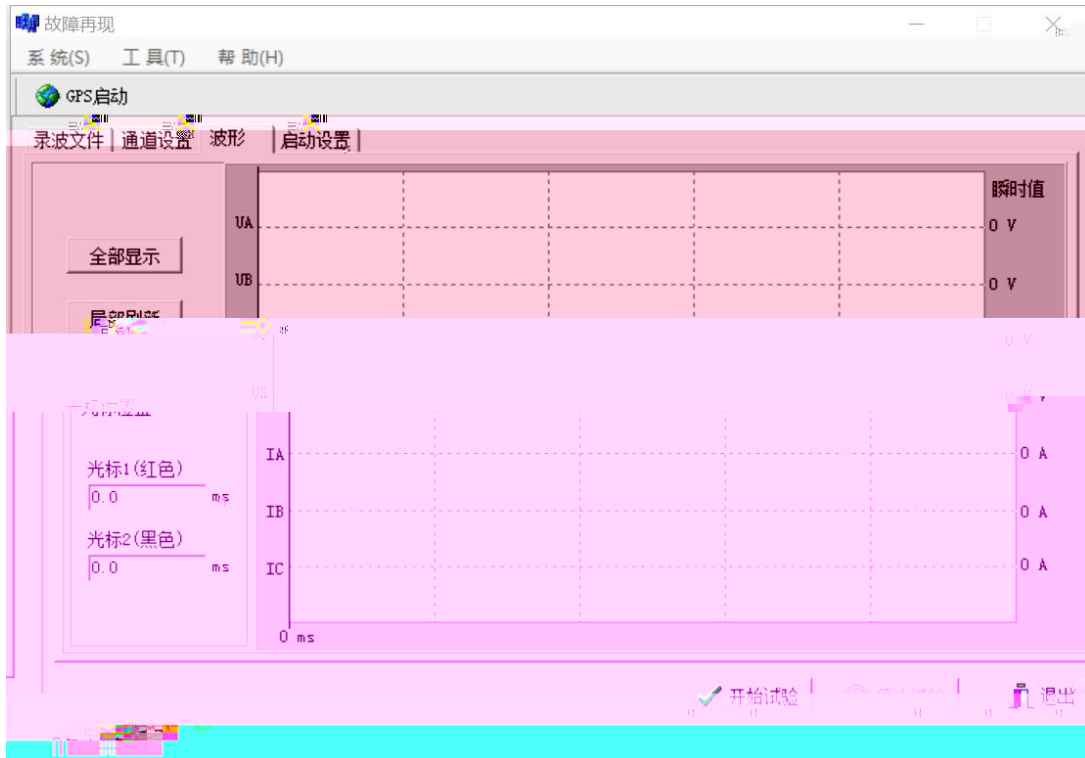

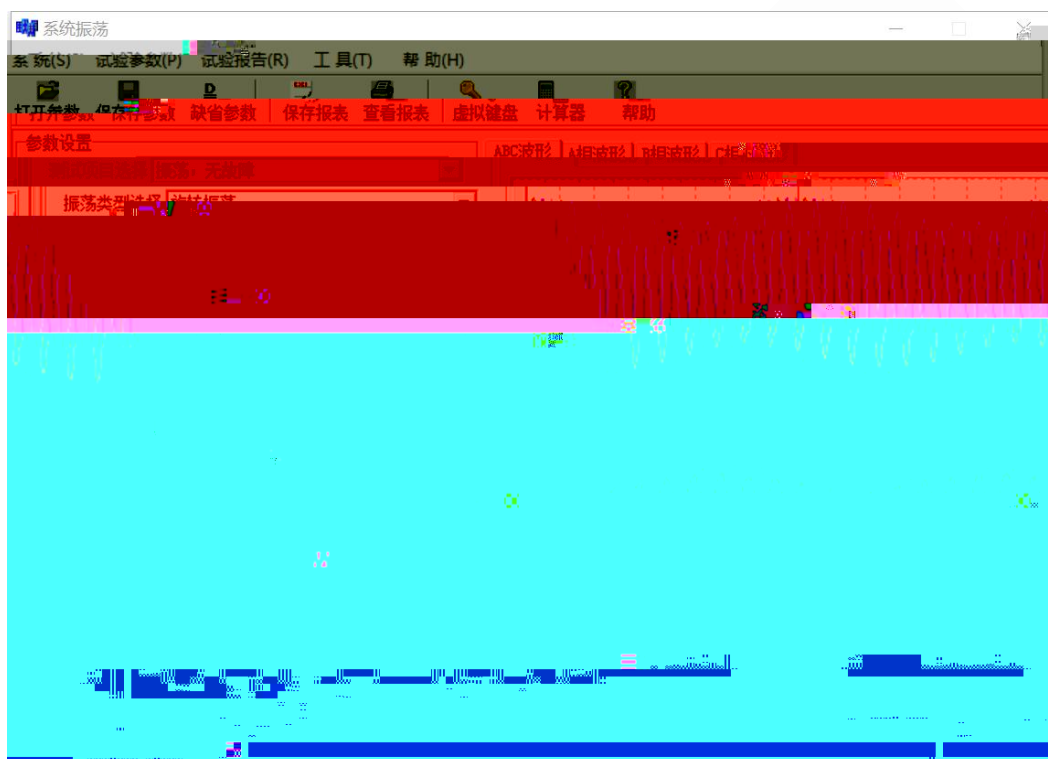



赫兹电力  
HERTZ POWER

产品宗旨：技术领先，质量可靠，轻便易用

服务宗旨：快速响应，**客户**到满意，**超过期**

赫兹电力  
HERTZ POWER

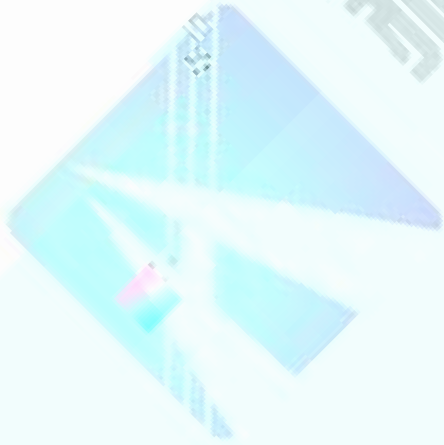

# PREED

赫 电力  
HERO POWER

产品宗 技术领先, 质量可靠, 便易用  
服务宗 快速响应, 客户满意, 过期



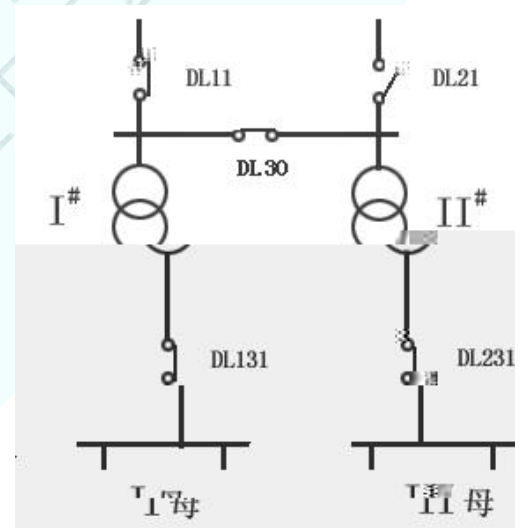
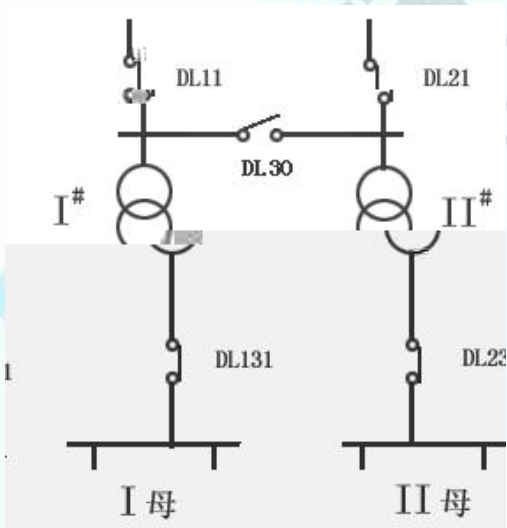
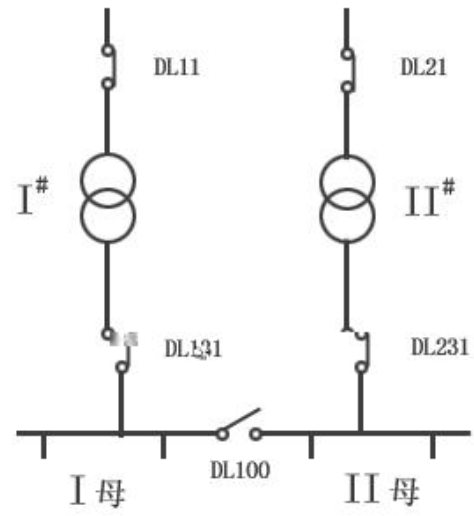
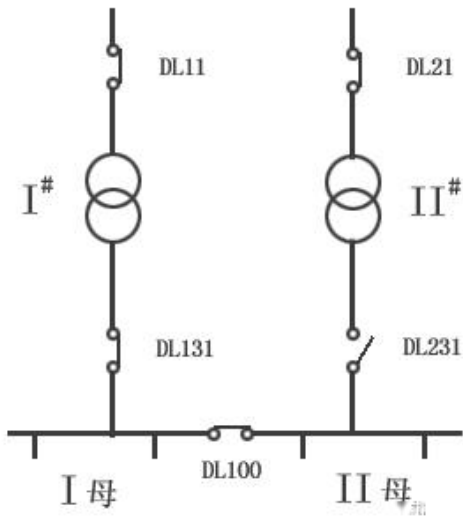



赫兹电力  
HERTZ POWER

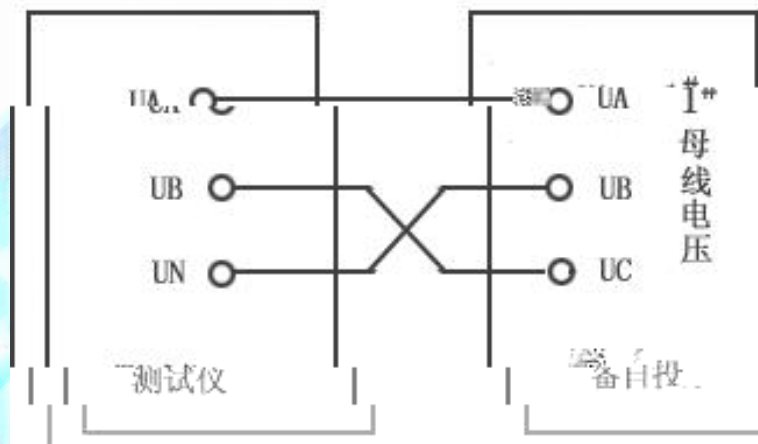
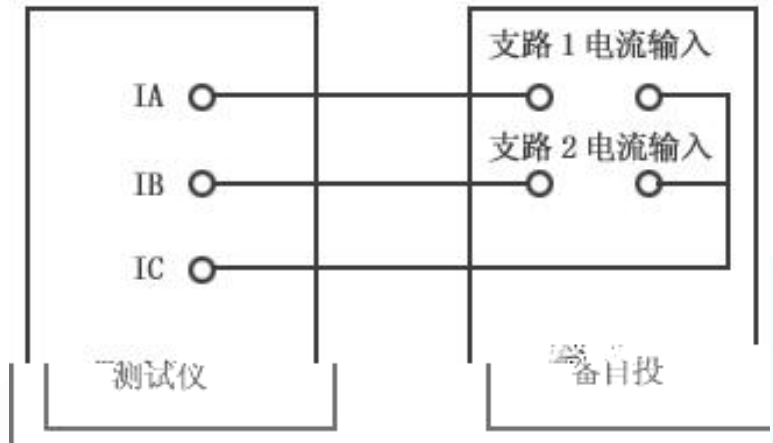

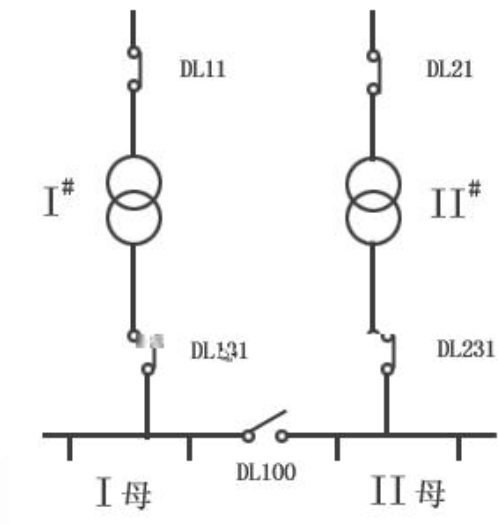

赫兹电力  
HERTZ POWER



赫兹电力  
HERTZ POWER

产品宗旨：技术领先，质量可靠，轻便易用

服务宗旨：快速响应，**客户**到满意，**超过期**

赫兹电力  
HERTZ POWER

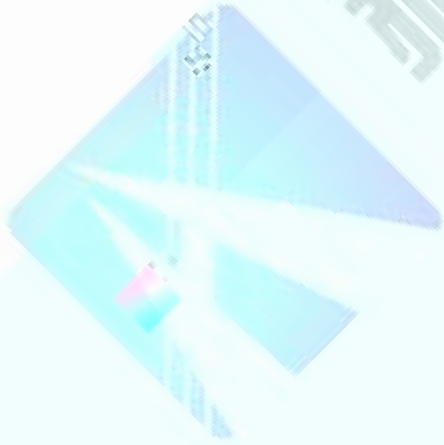

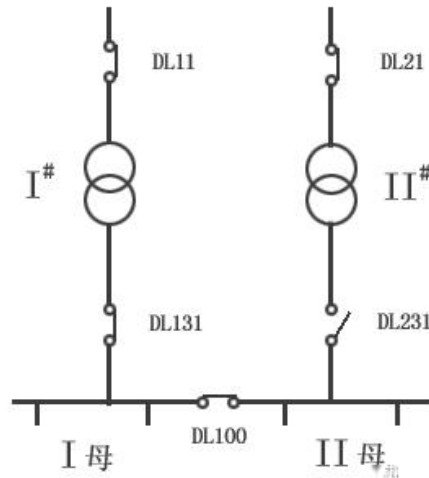

- 选中状态下的各相电压电流

UA	100.000	V	0.000	°
UB	100.000	V	60.000	°
UC	100.000	V	0.000	°
UX	100.000	V	60.000	°
IA	2.000	A	0.000	°
IB	0.000	A	-120.000	°
IC	0.000	A	120.000	°
IX	0.000	A	0.000	°

- 选中状态下的各相电压电流

UA	0.000	V	0.000	°
UB	0.000	V	60.000	°
UC	0.000	V	0.000	°
UX	0.000	V	60.000	°
IA	0.000	A	0.000	°
IB	0.000	A	-120.000	°
IC	0.000	A	120.000	°
IX	0.000	A	0.000	°

- 选中状态下的各相电压电流

UA	100.000	V	0.000	°
UB	100.000	V	60.000	°
UC	100.000	V	0.000	°
UX	100.000	V	60.000	°
IA	0.000	A	0.000	°
IB	2.000	A	-120.000	°
IC	0.000	A	120.000	°
IX	0.000	A	0.000	°



赫兹电力  
HERTZ POWER

产品宗旨：技术领先，质量可靠，轻便易用

服务宗旨：快速响应，**客户**到满意，**超过期**

赫兹电力  
HERTZ POWER

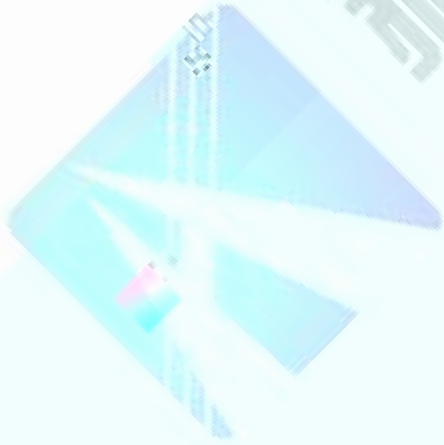

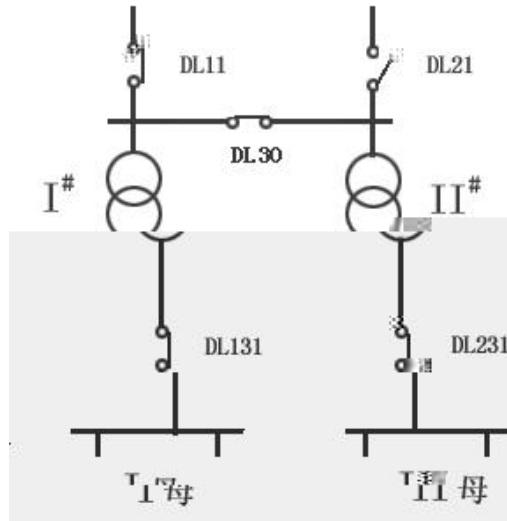

赫兹电力  
HERTZ POWER

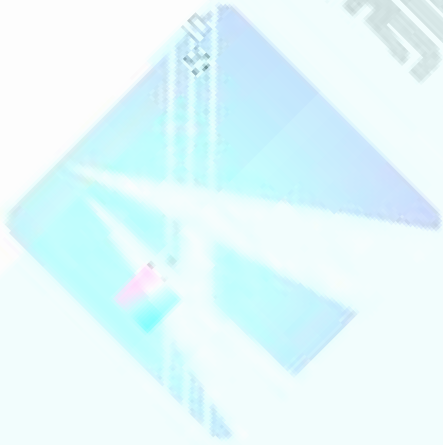



赫兹电力  
HERTZ POWER

产品宗旨：技术领先，质量可靠，轻便易用

服务宗旨：快速响应，**客户**到满意，**超过期**

赫兹电力  
HERTZ POWER

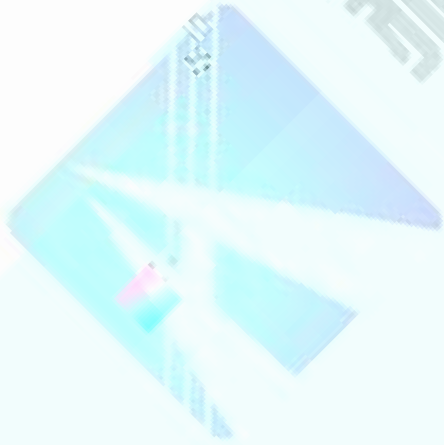

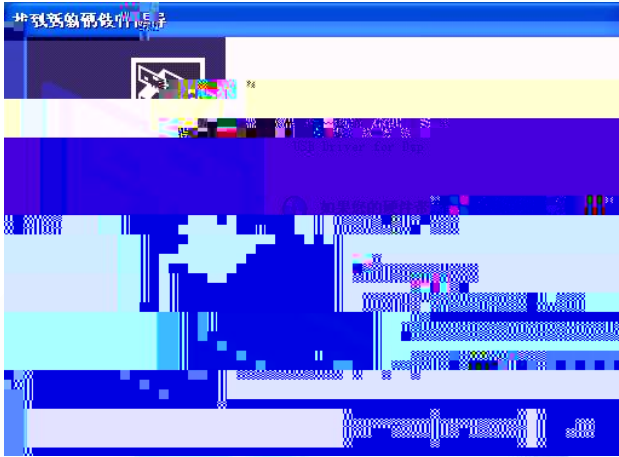
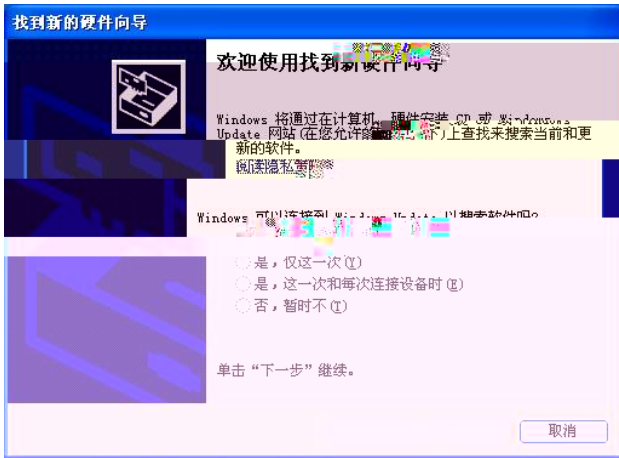





FOY AFxUNYÇÇ\$ D O

赫兹电力  
HERTZ POWER

F0d/2